

Report

Project title **Recyclability of packaging**
Assessment catalogue

Principal **Interseroh+ GmbH**

Project no. **530592**

Editor **Thorsten Pitschke, Dr. Siegfried Kreibe**

Review / comment: **Dr. Martin Schlummer, Benedikt Hantschmann (Fraunhofer IVV)**

Valid as of: **September 2022**

TABLE OF CONTENTS

1	Initiative.....	2
2	Key aspects of the assessment methodology.....	3
3	Target processes for mechanical recycling of packaging.....	5
4	Overview of assessment catalogue	19
5	Level 1: Allocation of the packaging to the collection system.....	22
6	Level 2: Sorting capacity of mixed packaging (LWP) collected.....	24
7	Level 3: Suitability for mechanical recycling and provision of secondary products	33
8	Quantitative recyclability assessment	53
	Literature	58

1 Initiative

For the purposes of encouraging recycling-friendly packaging design, discussions between the stakeholders in the value chain are essential. Platforms and offers for exchange already exist, some of which are exclusive, however. There is a wide-ranging need for further information on the requirements regarding recycling-friendly packaging design among developers, bottlers and the retail trade, though. In this respect, Section 21 of the German Packaging Act, which envisages the structuring of licence fees for sales packaging according to recyclability, offers a strong potential for steering. Through the ecological design of the licence fees, recyclable packaging should, in principle, be subject to low participation fees, while non-recyclable packaging should be subject to higher participation fees. Section 21 of the German Packaging Act addresses the question of a specific assessment of packaging recyclability in terms of the stakeholders who are involved in the life cycle of a piece of packaging. In the following, the key framework conditions for a methodology to determine the recyclability of packaging are presented. The starting point for the related considerations are, among others, the waste management regulations on the disposal of packaging, the Circular Economy Act as well as the German Packaging Act and the Packaging Ordinance in their currently valid versions. In addition to this, the framework which is formulated in DIN EN 13430, “Requirements of packaging regarding material recycling”, is also taken into account.

In the scope of the update which took place in September 2022, the assessment catalogue was adapted to the specifications of the minimum standards of the Central Agency Packaging Register [ZSVR 2022].

The goal of recycling is to reduce the use of raw materials and energy in the production of new products through the use of recycled materials. The term recyclability basically refers to the attribute of a product which allows the materials that are used to be returned to the material cycle at the end of their life cycle, thereby closing the material loop. In this context, the degree of recyclability depends on

- how the packaging is designed and configured,
- the quality and quantity in which the packaging can be made available to the material-specific recycling methods and processed accordingly
- which sorting and recycling techniques are used by the waste management industry to separate the individual material streams and concentrate them into target fractions with a high yield, and
- the level of quality that the recycled product achieves, in the knowledge that reuse as a substitute for the primary material is the pursued objective

2 Key aspects of the assessment methodology

2.1 Research subject

According to the definition in the German Packaging Act and DIN 55405 “Packaging - Terminology - Terms and definitions”, packaging is a product for the storage, protection, handling, delivery or presentation of goods which is passed by the manufacturer onto the user or the consumer.

The focus of this recyclability assessment concept is on sales packaging. Sales packaging typically accumulates with the end user after use, and is then collected via collection systems of the dual systems or, in the case of beverage packaging with a mandatory deposit, through the deposit system of the retailer. The packaging materials generally used, also referred to as packaging substances, are: glass, plastics, paper/board/cardboard (PBC), aluminium, tinplate and combinations or composites of these materials (for example, liquid packaging board). Several materials are often used in the packaging, some only in small shares. As regards the assessment, packaging aids such as labels or closures are also considered part of the packaging.

2.2 The distinction between recyclability / eco-design

For manufacturers and developers of packaging, the recyclability is, among other factors, a factor in the overall context of the “eco-design” of packaging. Other aspects discussed in this context include, for example:

- Eco-balance as a method for systematising and assessing environmental impacts over the entire life cycle of packaging. In this respect, the statement on the environmental impact is always a question of the systemic limits of the consideration. The consideration starts with the extraction of raw materials and can extend to the reuse as a recyclate in the production of new packaging or the additional consideration of the packaged goods.
- Material efficiency as a strategy for reducing the consumption of materials: the same result is to be achieved with fewer materials. The steps for achieving this range from material-saving manufacturing processes to improved product design, from staff training, through to cooperation with suppliers and customers. Material efficiency is primarily an issue in the manufacturing process, and not in the recycling process after the end of the use.
- Recycled content as a benchmark for the share of secondary materials in the new product. Working towards a (high) share of secondary materials is a step which encourages the closing of material cycles.

The aforementioned aspects of the eco-design of packaging can relate to different life cycle stages, which means goal-related conflicts between these dimensions are also possible. Within the framework of this concept, only the recyclability of a piece of packaging is assessed; conclusions on the further dimensions of eco-design cannot be drawn from this assessment.

2.3 Recyclability assessment

The determination of recyclability must take place in relation to an underlying recycling structure (for example, the collection, sorting and recycling processes that are used). In this respect, the recycling method (i.e. mechanical, raw-material-based and/or for energy recovery) and the quality of the respective recycling products in terms of the potential areas of reuse are especially relevant.

In encouraging mechanical recycling¹, the German Packaging Act (Section 21 [4]) provides the reference point to which the recyclability of packaging should make reference. Accordingly, in terms of the methodology presented, packaging which, after its collection and sorting,

- can be recycled mechanically to a high-quality, is considered to be **recyclable**.
On this basis, mechanical recycling into products which potentially replace the primary materials originally used is referred to as high-quality. The availability of the high-quality treatment capacities as well as the extent of the high-quality mechanical recycling is taken into account in the assessment.
- can only be recycled for the purpose of energy recovery, is considered **non-recyclable**.

The recyclability assessment also includes the aspect that the success of the mechanical recycling in terms of the existing recycling streams should not be placed at risk in terms of the quality and yield, due to the introduction of impurities, for example. Unwanted substances, materials or material combinations are to be identified during the assessment and assessed in terms of the possibility of their removal and their influence on the product quality.

The objective of the recyclability assessment is, on an efficient and valid basis, to determine the potential on whether and to what extent a piece of packaging or the materials or material combinations to be separated from it fulfil the respective physical or chemical requirements to remain in the path for high-quality mechanical recycling during the sorting and recovery processes.

In this context, a practical test to be carried out specifically for each piece of packaging at actual recycling plants to quantify the actual recyclability is not envisaged. The examination of the physical or chemical prerequisites of the characteristics is usually carried out on the basis of product information and experimental research.

2.4 Limits of the consideration

In principle, the recyclability assessment covers the entire waste management chain concerning the packaging following the end of use. These steps are:

- **Collection**
The delivery of the used packaging to the respective material-specific collection system (including possible separation by the consumer into packaging materials, capacity to be completely emptied, assessment of incorrect allocation to the collection system, etc.)

¹ According to the German Packaging Act, mechanical recycling is recycling with processes in which new material of the same substance is replaced or the material remains available for further material use

- **Sorting**

The sorting of collected mixed packaging

- **Preparation**

The material-specific, mechanical recycling of the packaging materials and the provision of a secondary product (for example, re-granulate)

During every stage of the recycling chain, the removal of packaging components can take place which are either unsuitable for high-quality mechanical recycling or do not apply to this path. With respect to the methodology to be developed in this case, recyclability is therefore to be understood as a gradual characteristic which ultimately assesses the relationship between the expected quantity of the secondary product and the quantity of the packaging material used.

The consideration of the individual process steps and products of the mechanical recycling is of importance to the recyclability assessment. Simply making a piece of packaging available for a high-quality mechanical recycling process as an indicator of its recyclability while calculating the recycling quotas, would fall short.

2.5 Status of the referenced waste management structure

The recyclability assessment is based on DIN EN 13430 (Packaging – Requirements for packaging recoverable by material recycling) on the basis of the collection and recycling processes which are relevant and used at the industrial level in Germany today (status quo). A more detailed description of the material-specific recycling processes is provided in Section 3.

2.6 Summary

The recyclability assessment for a piece of packaging characterises the share of materials contained in the packaging which can be reused to manufacture products from the original primary material subsequent to the sorting and recycling. Accordingly, to determine the expected recyclability, the chemical and physical suitability of the packaging is assessed in terms of its sorting capacity and recyclability. The reference point for this assessment is provided by the sorting and recycling processes specific to packaging materials which are relevant and used at industrial level in Germany.

3 Target processes for mechanical recycling of packaging

After its use, sales packaging is collected separately from residual waste on a material-specific basis via the collection systems or, in the case of beverage packaging with a mandatory deposit, through the deposit system of the retailer.

In this respect, consumer behaviour and the basic manageability of the packaging during the separate collection must firstly be taken into account. One example of this is the possibility for the allocation to the collection system on the part of the consumer. This takes place as soon as the waste packaging can be clearly allocated to the collection system created for it. Container glass, for example, can be classified as clearly sortable, as the material of glass is clearly

recognisable as such to the consumer. The same applies to the allocation of metallic packaging to the respective separate collection systems (if available). This can also be assumed to be the case for the unambiguously correct allocation of plastic sales packaging to the designated collection methods (yellow bag, yellow bin). It becomes more difficult when the packaging consists of different materials that the consumer has to separate into individual components (for example, yogurt cups: aluminium lid, thin plastic container with a cardboard sleeve). The consumer is required to make his or her personal contribution to the correct technical sorting process. Not all consumers are prepared to do this, which is why losses in the individual packaging components can be expected here as well.

The following illustration of the preparation chains for the various packaging waste shares describes a wide-ranging non-exclusive state of the art. In general, the processes and process chains presented provide the procedural framework for the recyclability assessment, i.e. the visual and physicochemical treatment processes that are presented are used in order to assess the recyclability.

Process-based innovations in the preparation sector may make it necessary to adapt the described state of the art in the future.

3.1 Sorting of mixed LVP

Lightweight packaging (LWP), i.e. sales packaging made of plastic, aluminium, tinfoil and composite materials such as liquid packaging board, is usually collected in mixed form. The collection mainly takes place in the collection system. The mixed lightweight packaging is then sent to recycling plants and separated into fractions for downstream recycling. The outcome of the sorting is influenced by contractual and legal requirements as well as factors which can be attributed to the technical design of the sorting plant and its mode of operation. The state of the art for the sorting of lightweight packaging is currently characterised by highly-automated processes and the separation of plastic packaging according to the types of plastic. The sorting of lightweight packaging according to the state of the art generally results in the sorting fractions of tinfoil/ferrous metals, aluminium, PS, PE, PP, mixed plastics (MP), PET, PBC and liquid packaging board (LPB), which are potentially suitable for mechanical recycling. There is no uniform specification regarding the product range which is to be sorted. The quality requirements concerning these fractions (product specifications), regarding their purity, for example, are set out in a joint catalogue by the system operators². The key steps when sorting a mixed collection of lightweight packaging according to the state of the art are illustrated in Figure 3-1 (also see [Dehoust et al. 2012]):

- Opening of containers (e.g. yellow bag) for the mechanical separation of the waste packaging
- Screening classification as preparation for the size-based sorting stages and for the removal of small-scale sorting residues (<20 mm)
- Air separation of fractions >220 mm and 20–220 mm for the removal of plastic films and/or a fraction of **flexible mixed plastics**
- Magnetic separation for the extraction of **tinfoil** or **ferrous metals**

² For detailed information, see <https://www.gruener-punkt.de/de/download.html>

- Removal of **liquid packaging board (LPB)** with near-infrared sensor technology from the 20–220 mm fraction (windblown heavy and light fraction) and the partial stream from the eddy current separation
- Ballistic separators for separating the material flow into two main fractions such as "rolling main fraction" and "flexible light fraction"
- Eddy current separation for the extraction of **aluminium**
- Multiple sorting of rigid plastics, particularly with the use of near-infrared sensors (NIR). In general, four fractions of plastic types (**PET, PS, PE and PP**), one **MP (rigid)** and one **PBC** fraction are generated.
- Manual control of the automatically-removed sorting fractions

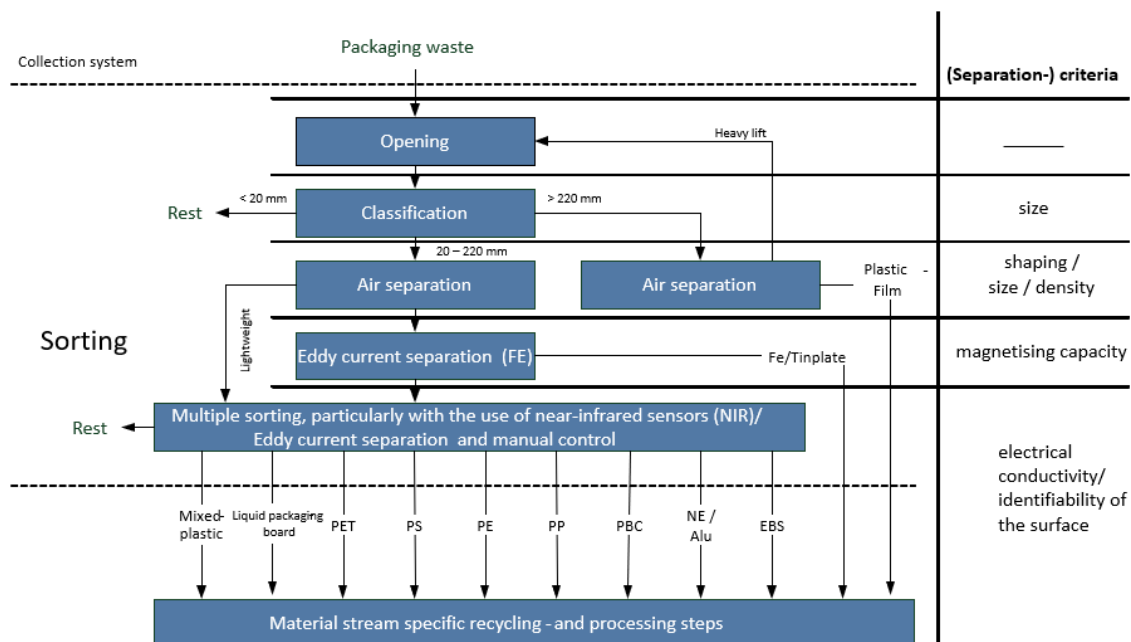

Figure 3-1: Process steps for sorting LWP

The sorting fractions which result at the sorting plant are required to fulfil certain sorting specifications in order to be suitable for the downstream recycling channels. During the consideration of recyclability, the point of sorting capacity according to the state of the art plays a key role. The typical sorting fractions are:

- Plastic types: PP, PE, PET, PS, films > DIN A4 and mixed plastics
- Metals: Aluminium, tinplate
- Fractions containing paper fibres: Liquid packaging board, PBC composites
- Other: Sorting residue, high calorific value fraction (EBS)

3.2 PE, PP, PS and films

The recycling of packaging plastics mainly involves bulk plastics which are in the thermoplastics category. Thermoplastics can be reshaped within certain temperature ranges. As long as there is no overheating, and therefore damage to the material, this process can be repeated to a certain extent. The frequency to which this repetition can take place essentially depends

on the quality, i.e. purity, of the material stream. Of the thermoplastics, the polyolefins polypropylene (PP) and polyethylene (PE) are used particularly frequently in the packaging industry. The sorting fractions with the corresponding specifications are forwarded from the LWP sorting plants to the further recycling stages specific to the material stream. The basic procedure for further processing is illustrated in Figure 3-2.

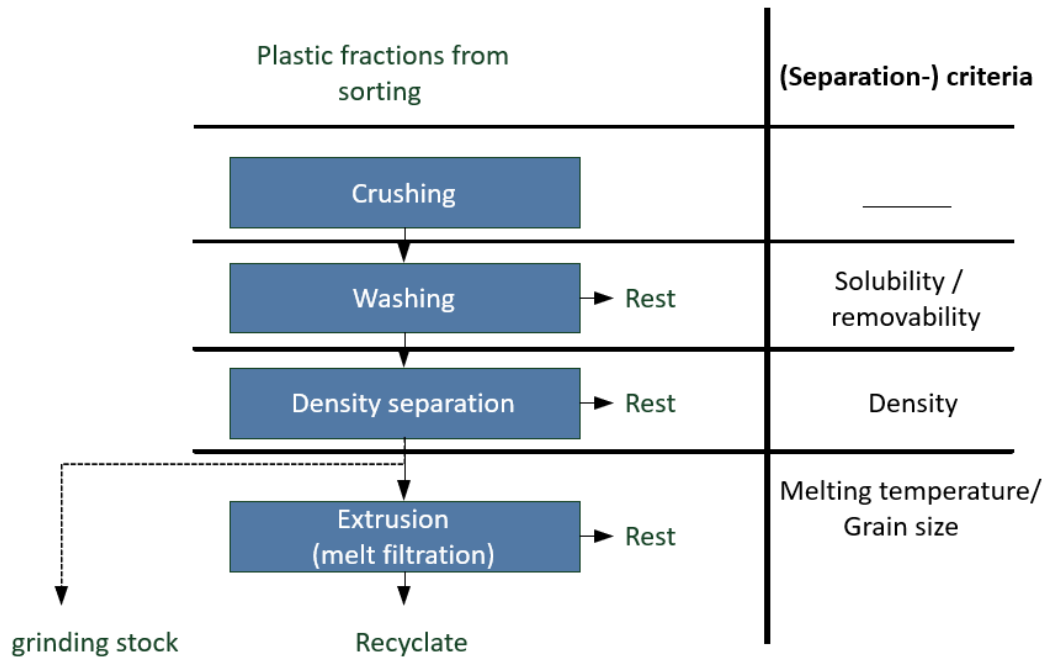

Figure 3-2: Process steps for the recycling of standard packaging plastics [UBA, 2016-1]

The further processing of plastic packaging made from PP, PE and PS essentially involves the process steps described above. The PP, PE and PS sorting fractions have a purity of at least 94%. In the recycling process, the first step after the opening of the bale is the crushing of the plastic components. During the subsequently intensive washing, residues of the filling material, adhesions, labels, etc. are to be removed as far as possible. In this respect, no washing substances are generally added, as the plastic products usually still have enough surfactants adhering to them to ensure a sufficient cleaning effect. Material composites which cannot be dissolved in the washing process can lead to challenges in the further processing steps.

In a subsequent density separation in the float and sink process, the target plastic (float fraction for PE or PP recycling and/or sink fraction for PS recycling with 2-stage density separation) and the impurities are removed to further increase the purity of the polymer fraction. However, this has its limits if materials with very similar densities are to be separated from each other or if adhesions (for example, multilayers or PBC residues) on the target polymer change its original density.

The key processing step towards the recyclate is the extrusion, including the melt filtration of the dried plastic components. In the extruder, the material is melted, homogenised, degassed and filtered.

During the classification of the LWP mix, the film fraction is removed before the separation of the metal. As a rule, the films separated in this way are larger than DIN A4 and mainly consist of LDPE. The films are then crushed and processed into grinding stock. However, because the

grinding stock obtained in this way has a low bulk density, which is not cost efficient for the further transport to the recycling unit, an agglomeration takes place as an intermediate step. The friction causes the ground material to heat up, melt and combine with other particles, which causes it to bind together to create a more compact particle. In some cases, a washing stage is introduced before the agglomeration. This allows adhesives and residues of beverages and food to be removed. Labels (and other adhering paper) are also removed in this way. The washing takes place according to the target process. The washing takes place if the grinding stock is to be further processed into a re-granulate or even a product. If impurities and adhesions do not have any detrimental effects during further processing, the washing process does not occur, as it has a significant impact on the cost of the re-granulate. The plastic is then homogenised in the extruder, melted and usually processed into re-granulate.

3.3 PET

PET recycling currently focuses on transparent PET bottles from the deposit system or the sorting of LWP. Rigid packaging made of PET, such as trays, is not currently mechanically recycled³.

It is necessary to separate the recycling of PET bottles into the bottle-to-bottle cycle on the one hand and the production of PET flakes for use in the non-food area on the other. The key steps are shown in Figure 3-3.

³ See “Falscher PET-Einsatz: Das kann so nicht bleiben” (Wrong use of PET: things can’t stay this way!)
<https://www.k-zeitung.de/falscher-pet-einsatz-das-kann-so-nicht-bleiben/150/1085/81998/>

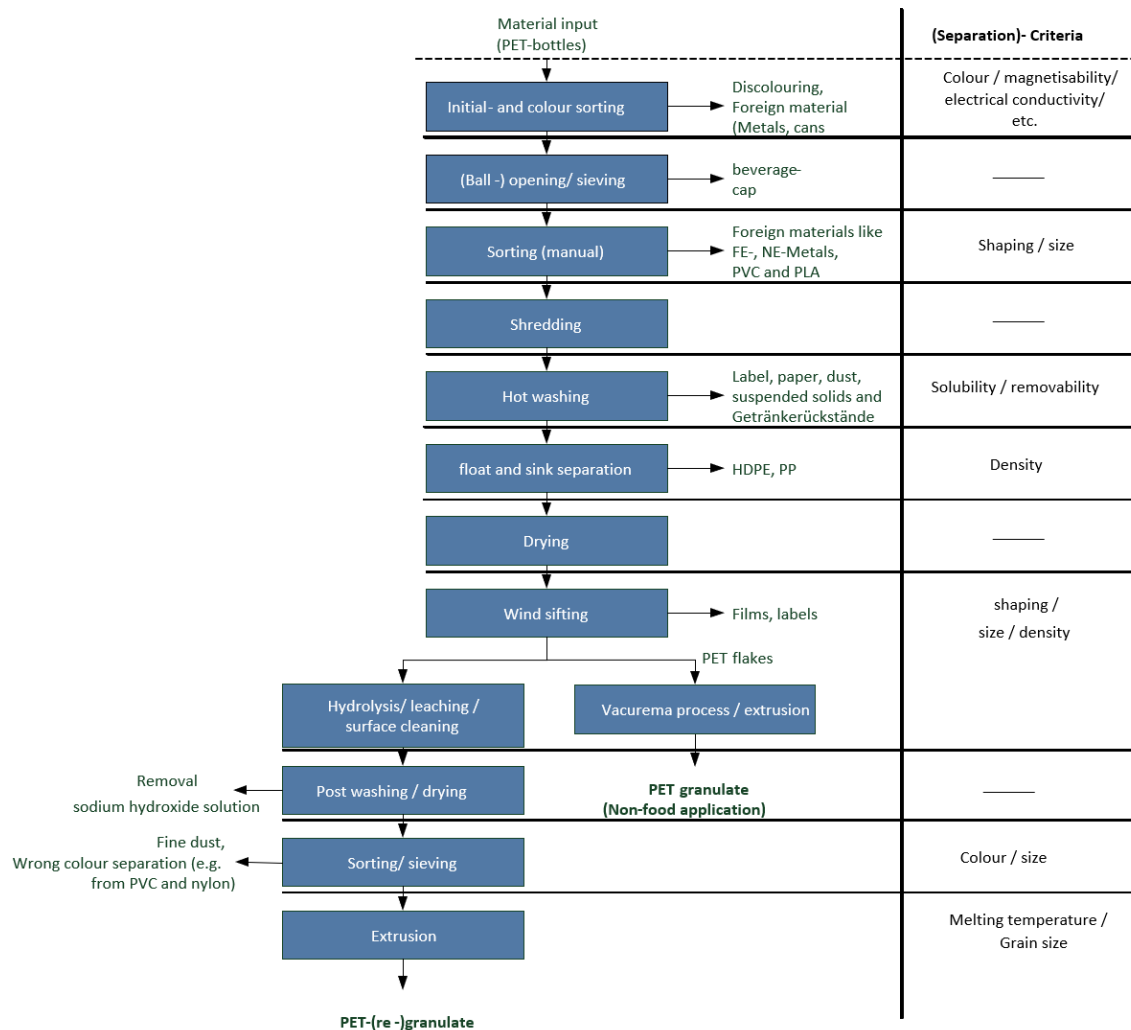

Figure 3-3: Process steps of PET recycling (bottle-to-bottle on the left and non-food on the right), according to [UBA_2016-1]

After the initial sorting, the collected PET bottles are crushed into “flakes” in a grinder, and the labels, beverage residues and other particles of dirt are removed with the addition of hot water and lye. Closures, etc. are separated in the course of a float and sink separation. The recycling of the closure material (PE, PP) usually takes place. Due to their higher density, the PET flakes remain in the sinking fraction, and are dried and freed from other impurities in an air separator. In the URRC process for the production of food-grade PET flakes, the surfaces of the flakes, including the adhering impurities, are detached in a hydrolysis process with the addition of sodium hydroxide solution, thereby completely cleaning the material. After the lye is washed off, the PET is dried and any remaining impurities are removed. In the final extrusion, the PET shares are transformed into re-granulates or, in the case of PET bottle production, into a “pre-form”.

Other processes exist for the use of the PET recyclate in the non-food sector. The Vacurema process, for example, is very similar to the URRC process, although no hydrolysis takes place, but a direct extrusion and processing of the recyclate into films or fibres, for instance.

One of the problems with PET melt filtration is that the high melting temperature of PET means organic impurities are carried over into the recyclate, which considerably reduce its quality. In

this respect, PA copolymers may be introduced into the product, which can lead to a yellowish colouring of the recycle. If this is the case, the recycle can only be used for the production of coloured bottles.

3.4 Mixed plastics (MP)

As with the separated types of plastic, shares of MP are suitable for processing into intermediate plastic products (for example, re-granulates), and are therefore potentially open to a wide range of plastic applications. If the MP is recycled mechanically in this way, the basic process steps for the wet mechanical recycling of plastics apply (crushing, washing, density separation and extrusion; also see Figure 3-2), whereby the product requirements are generally less demanding compared with re-granulate from different types of plastic.

However, MP is often converted directly into finished products during the course of dry processes, through intrusion processes (such as noise barriers, construction fence bases), for example, although this does not usually substitute the use of primary plastics⁴. Following agglomeration with the addition of dyes and/or film agglomerates, the fine-grained mixed plastics are processed further into products in intrusion processes [Bosewitz, 2013].

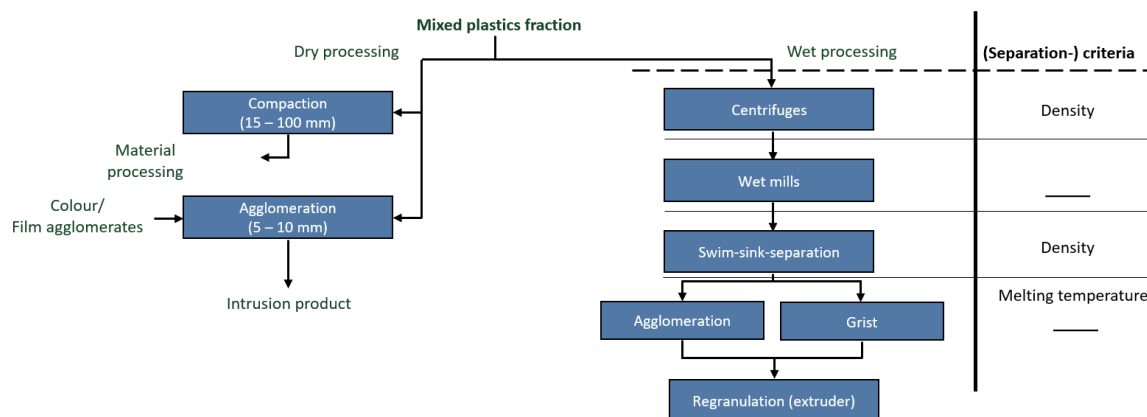

Figure 3-4: Overview of the processing methods for mixed plastics [Bosewitz, 2013].

Wet mechanical preparation for the production of re-granulate, for injection moulding applications, for example, is the highest stage in the refinement process for the mixed plastics fraction. Here, the differentiation of the various plastics is only carried out after the decomposition by means of density separation processes. The shares that are not re-granulated are recycled via the EBS path. The re-granulate yield and the re-granulate quality depend on the initial composition, moisture, residual adhesion, labelling, etc., and, in particular, on the share of dimensionally-stable polyolefins. Depending on the quality of the mixed plastics, yields of between 40% and 60% can be recorded.

⁴ According to [Consultic 2015], approximately 60% of mechanically-recycled MP is to be found in such products.

3.5 Liquid packaging board (LPB) and PBC from LVP (PBC composites)

With the primary material of LPB, it is necessary for its purity subsequent to sorting to total at least 90%. Here, the goal of the preparation is to recover the pulp fibres for paper mills. This means that the plastic-aluminium share has to be detached gently from the board, which requires a separate process line, something which has only been realised at a few plants in Germany.

A key procedure when recycling of LPB is the washing process, in which the fibres are separated from the shares of aluminium and plastic. To achieve this, the material is shredded before being fed into a large, approx. 30-metre-long washing drum. With the addition of water (no chemicals are used), the mixture is pulped in the rotating drum. At the end of the drum, the fibre pulp is washed off through small openings, resulting in the separation of the film remnants from the aluminium share. The fibre pulp is relieved of foreign matter in cleaning stages and then, after thickening, fed to the processing lines for the further production of (recycled) paper. The rejects, consisting of the film-aluminium share, are mainly used in the cement industry. On the one hand, the film residues provide the energy for burning the clinker, while on the other, the aluminium oxide is used to improve the setting attributes of the cement. The key steps for the recycling of LPB are illustrated in Figure 3-5. [LPB, 2007]

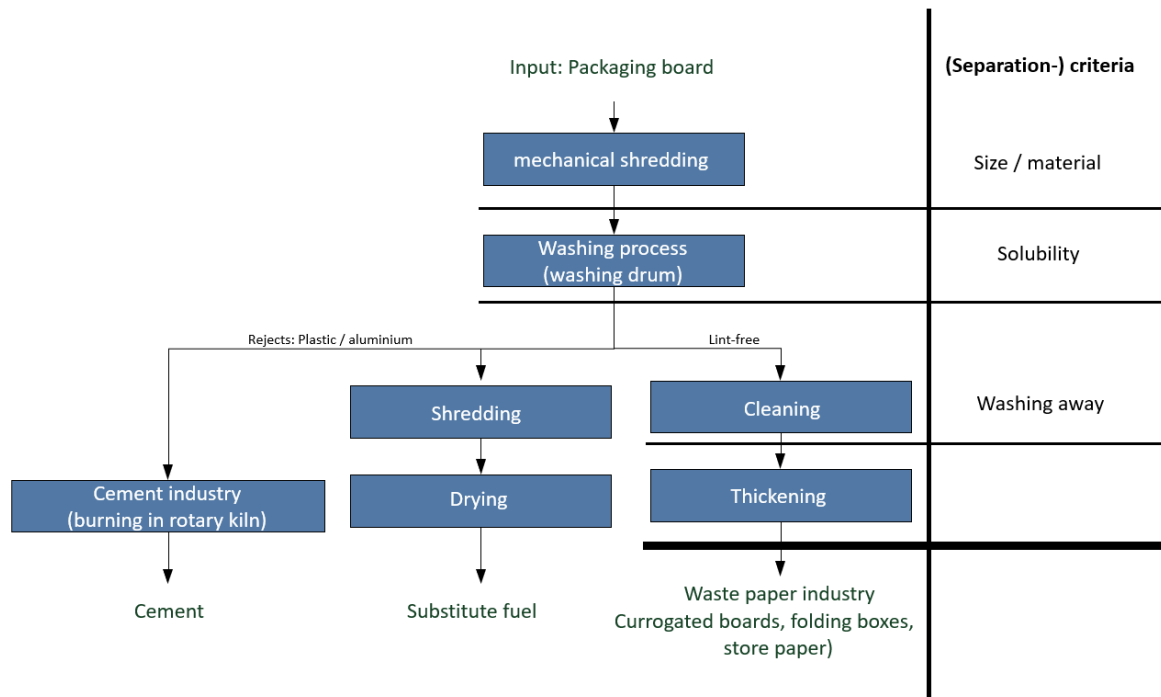

Figure 3-5: Process steps in liquid packaging board recycling [LBP, 2007].

The plastic-aluminium fraction poses problems during the subsequent recycling. Separating these two components is not easily achieved⁵.

⁵ In Finland, a process is used in which the film fraction is heated in a gas reactor at approx. 400 C. In this process, the plastics are transferred to the gas phase, while the aluminium remains in solid form and can be separated. The gas is used to generate steam, which is used for drying processes in the paper industry, or to generate energy in a turbine. The aluminium is separated and sent for further recycling.

During the recycling of the composite-rich sorting fraction PBC from LWP, the key process steps are similar to those when recycling the LPB fraction. Here, the recovery of the fibre share is also the goal. Once again, an essential process step in this case is a washing process with corresponding dwell times, so that the composites can become detached from each other. Components which cannot be separated from each other are discharged as rejects and usually sent for thermal recycling.

3.6 Aluminium

As part of the LWP fraction, aluminium is often found in films and composite packaging. Pyrolysis has become the established process when recycling aluminium from the LWP collection. The key steps of the procedure are illustrated in Figure 3-6 (see [GDA, W 18] and [Erdmann et al. 2009]):

- Crushing
- Removal of impurities via magnetic / eddy current as well as float and sink separators
- Pyrolysis (rotary kiln pyrolysis with downstream bench annealing) for the removal of organic impurities
- Melting, usually with the addition of melting salts and removal of oxidic aluminium component

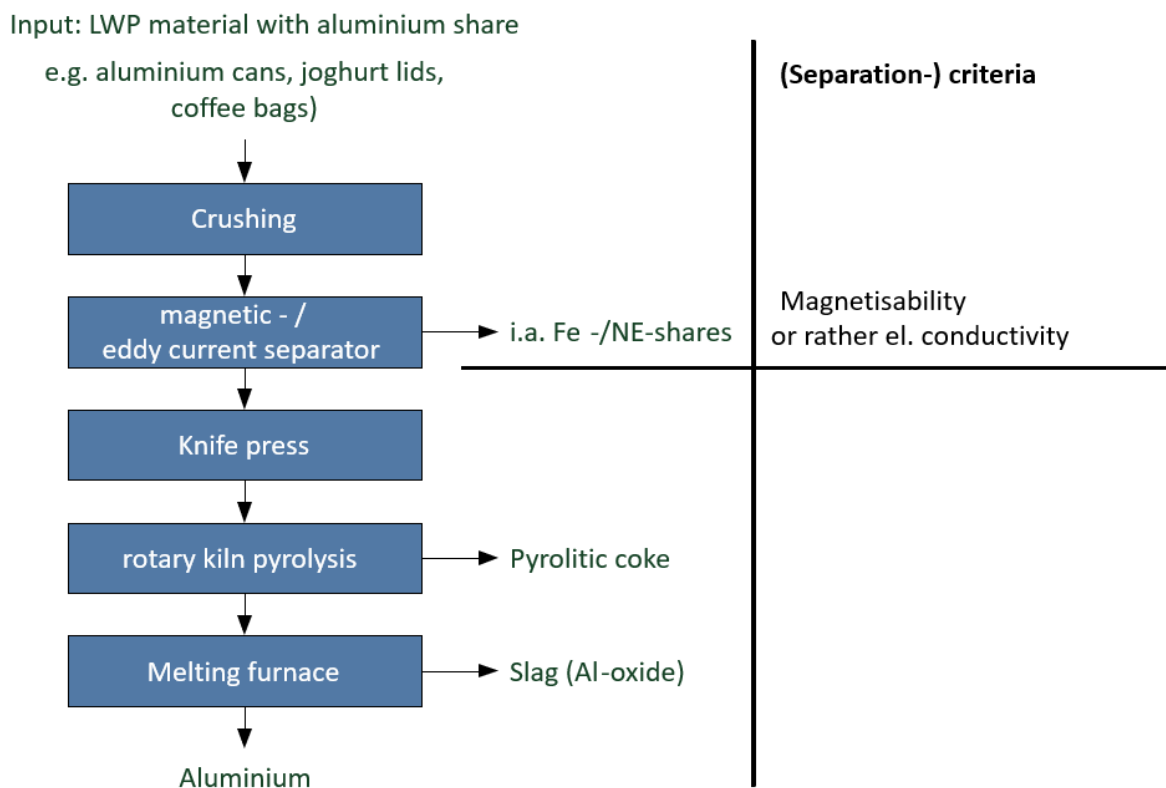

Figure 3-6: Recycling process of LWP aluminium, [GDA, W 18]

Since pure aluminium is too soft as a material for many applications and areas of use, it is necessary for other metals such as silicon, copper or magnesium to be added to it in order to

achieve the requisite strength. However, it may be the case that these alloys cannot be separated in the recycling process. This means that analyses on the composition of the alloy at the beginning of the process are important so that a new recipe/alloy can be heated with the addition of pure aluminium in the converter/furnace.

Another problem when recycling aluminium is the coatings on the metal components. As a base metal, aluminium is a highly reactive element and easily forms compounds with other substances. When the aluminium is melted down, dross is produced as a residual material, which still has a high metal content and has to be recycled further in order to make these high metal shares usable again. Through the addition of salts (usually chlorides), the share of dross produced is minimised, although this processes produces salt slag which also has to be disposed of. [GDA, W 18]

3.7 Tinplate / ferrous metals

Tinplate or ferrous metal packaging which is collected as part of the LWP collection in or drop-off collections ideally enters the waste stream in the form of beverage or food cans. Tinplate packaging is easy to separate from the rest of the LWP mix because of its ferromagnetic properties.

The steps carried out for the preparation are (see Figure 3-7):

- Crushing for the decomposition of the material
- Removal of metallic and organic impurities, using non-ferrous precipitators and separators, for example
- Melting through use in the electric arc furnaces and/or in the oxygen converter with use in the blast furnace route

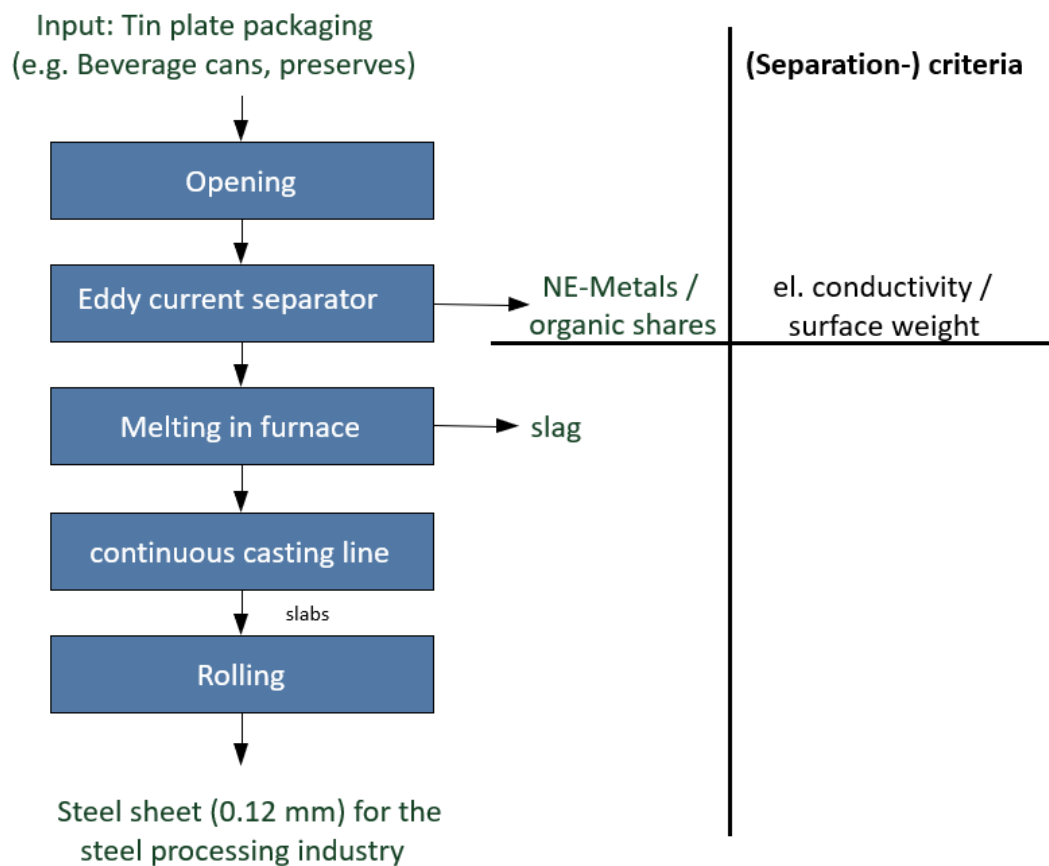

Figure 3-7: Recycling process of LVP tinplate

After the packages of scrap have been separated again, the further separation of non-ferrous metals is carried out using a magnetic separator. The metal waste is then remelted and processed in the blast furnace or converter so that it can be sent to the steel industry in the form of steel sheets. In this process, organic impurities are oxidised through the insufflation of oxygen. Other inorganic elements either pass into the metal as alloying constituents⁶ or are removed as slag [UBA, 2016-1].

⁶ To separate the tin from the steel sheet in the case of tinplate, the waste is initially subjected to electrolysis.

3.8 PBC

A material-specific recycling method applies to PBC, including sales packaging collected separately from other packaging waste in the collection or return system. The main source materials for recycling PBC are graphic paper, corrugated board, cardboard and other packaging paper. The process steps used during recycling serve the purpose of separating the waste paper or the fibres from contaminants and impurities and then making the fibres available for paper production. The key steps in the dry sorting of mixed PBC are, according to the state of the art (also see Figure 3-8):

- Classification and/or removal of coarse and fine material with the use of ballistic separators
- Magnetic separation in order to separate ferrous metals
- Mechanical cardboard separation, with the use of a rotor sieve, for example
- Sorting of the material stream using near-infrared scanning systems (NIR)
- Manual final sorting by hand

The further preparation takes place in the paper mill, with the following steps:

- The waste paper material is suspended in a pulper with water (activation/pulping).
- The suspended fibrous material is then subjected to cleaning, among others, with the use of classifying units and vortex centrifuges (cleaning).
- Pigments, solvents and binding agents in the printing inks are dissolved and removed from the fibres. In the case of flotation deinking, water, caustic soda and soap are added to the paper pulp in a flotation cell. Air nozzles create a foam to whose bubbles the ink components attach themselves. These float to the surface and are removed (ink removal / deinking).

The rejects that are removed during the preparation (contaminants, non-soluble components) are mainly used for energy recovery.

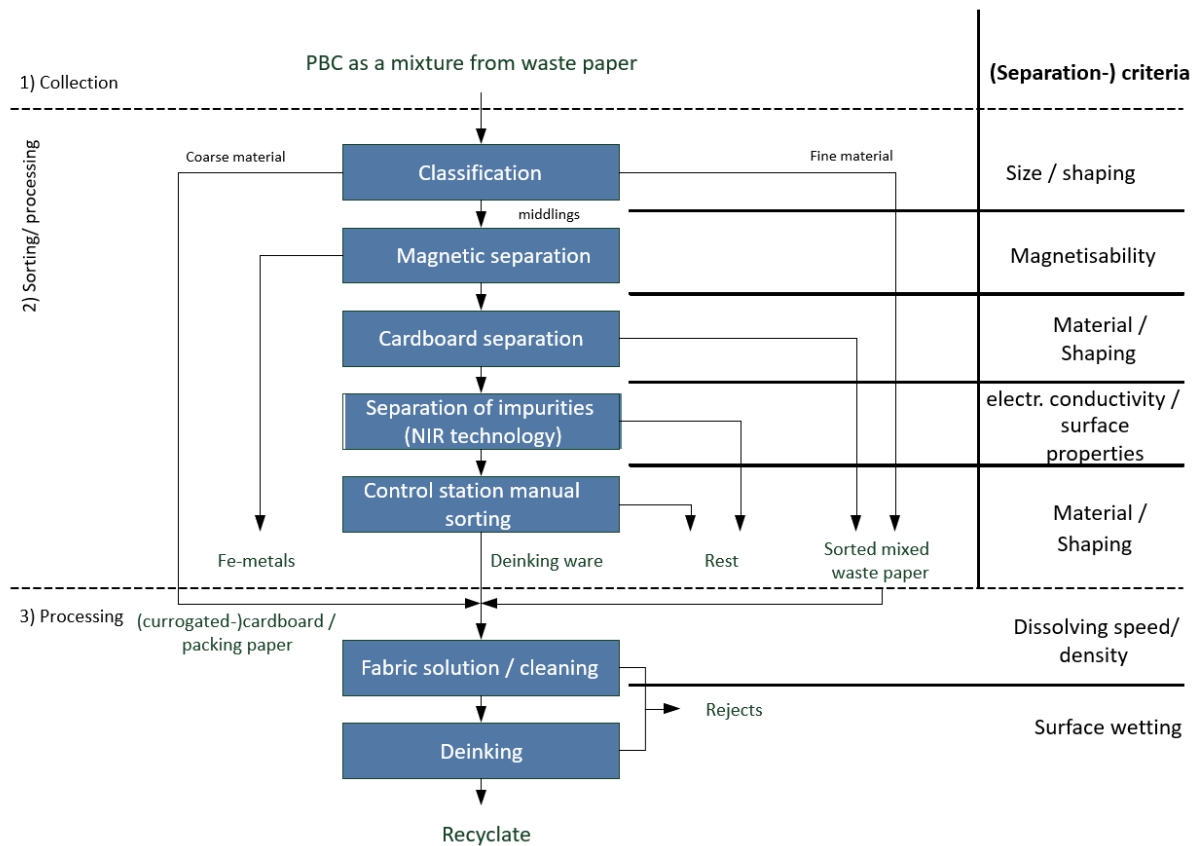

Figure 3-8: Process steps of PBC recycling [UBA, 2016-1].

One of the challenges during the recycling process is printing inks which cannot be removed from the waste paper with the use of standard deinking processes. Problems are also caused by particular adhesive impurities, known as stickies (from adhesive labels or hot-melt adhesives in brochures, for example), which are fragmented and can therefore no longer be removed. Stickies can cause damage in the subsequent process. They can adhere to machine components which come into contact with the paper web and lead to web breaks [Gruber, 2011].

3.9 Container glass

A material-specific recycling method applies to container glass, which is mostly collected separately by colour in the drop-off collection system. The purity of the used glass is the key requirement of the process. In this respect, the key steps in the preparation are (see [bvse 2016, [Erdmann et al. 2009]]):

- Basic sorting and colour sorting
- Crushing, with the use of an impact crusher, for example, and classification to ensure an optimum and homogeneous waste stream for the downstream sorting equipment.
- Washing for the removal of labels and coating residues (friction washing). The associated cleaning means that the glass shares can be distinguished from the ceramic-stone-porcelain (CSP) components in the subsequent process more easily.
- Removal of ferrous (magnetic separator) and non-ferrous metals (eddy current separator)
- Light, areal impurities (for example, plastics) are removed by means of air separators.

Current, preliminary status of the processing. Retroactive adjustments in the course of the further processing are possible.

- Ceramics, stones and porcelain (CSP) and off-colours are selected via optoelectronic systems.
- Final sorting (screening, classification) to remove final off-colours and foreign matter.

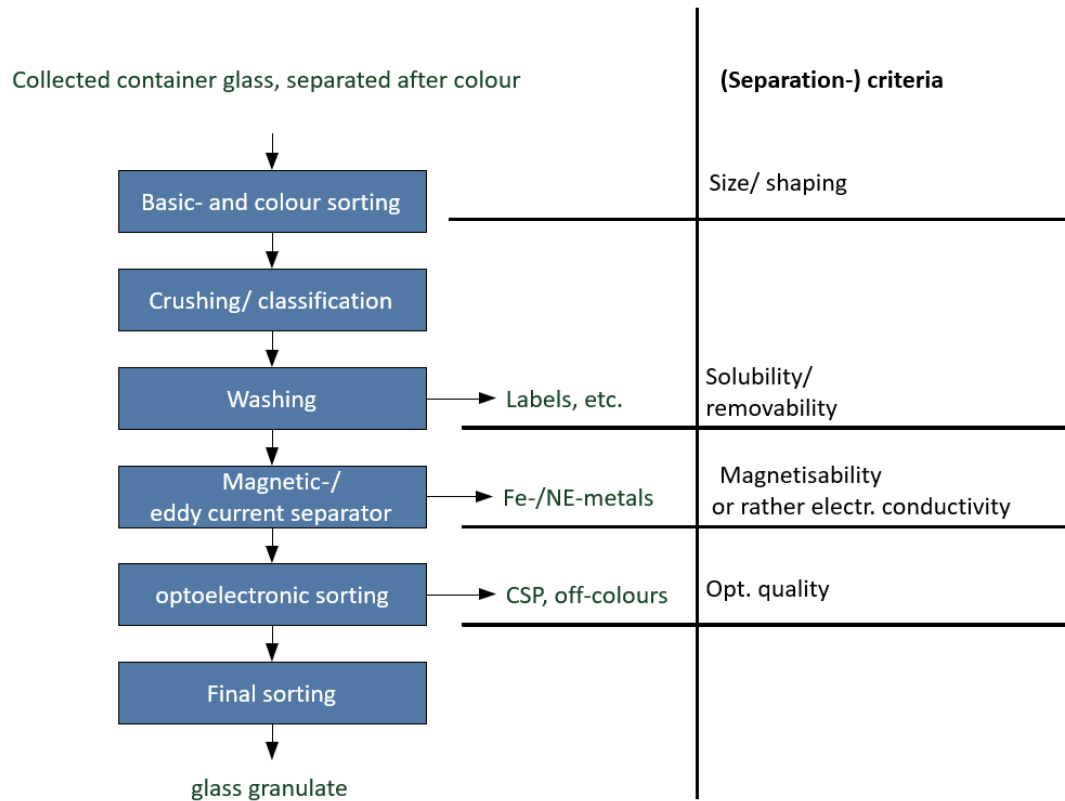

Figure 3-9: Process steps of container glass recycling

At the end of the process, a glass granulate is available which corresponds in quality to the original raw materials for the production of container glass. In the subsequent recycling process in the glassworks, the processed waste glass is mixed with sand, soda, lime and aggregates, before being heated and melted.

4 Overview of assessment catalogue

The following describes a widely-applicable standard procedure for assessing the recyclability of packaging⁷.

The assessment system is divided into three levels, each of which is structured by specific assessment criteria:

- Assessment level 1: Allocation of packaging to the collection system
- Assessment level 2: Sorting capacity of mixed packaging (LWP)
- Assessment level 3: Suitability for mechanical recycling and provision of secondary products

In level 1, the ability to allocate the packaging to the intended collection system is highlighted. Level 2 essentially assesses the recyclability in terms of the target material as to whether, following collection in the form of a mix with other packaging, the packaging which is to be assessed can be identified or sorted for preparation for mechanical recycling processes. The key identifying attributes of mixed packaging are the magnetising capacity (tinplate packaging), electrical conductivity (aluminium packaging) and NIR identifiability of the surface (plastics, PBC, liquid packaging board).

Assuming that the packaging has generally been sorted into the sorting fraction⁸ intended for the target material, in level 3, the yield and quality of the secondary material obtained from the packaging are finally assessed. In this respect, the key criteria are the share of removable and non-recyclable packaging shares and unwanted inputs into the secondary product and/or the recycling process.

The prerequisites and assumptions for the assessment of a piece of packaging are that

- the packaging is eligible for licensing
- the consumer correctly allocates the packaging or packaging components to the intended collection system for packaging – subject to the criterion described in Section 5.1 – without exception
- the consumer returns the entire packaging after use, i.e. without removing individual packaging components, to the designated collection system. Exceptions to this are packaging components
 - which must be immanently and irreversibly removed in order to use the contents (for example, transparent film around CD sleeves, disposable tear-off cap, crown caps) or
 - which are loosely connected to the packaging and can therefore be completely separated from the packaging for normal use without separation measures (for example, cutting, twisting, tearing) by the consumer (for instance, outer packaging, insert bases, boxes for sweets, snap-on and snap-off lids)

For these packaging components, the recyclability is to be assessed separately from the actual packaging.

⁷ Definitions of the term “packaging” according to the Packaging Ordinance (VerpackV) Annex V (to Section 3 (1) no. 1).

⁸ Regarding the management of special cases for consideration in level 3, see Figure 7-1

Not taken into account are the possible separation by the consumer of packaging combinations which can be pulled apart by hand and their material-specific delivery to the corresponding collection systems (in this context, a “3K yogurt pot” would be assessed as a packaging unit consisting of a plastic cup, a paper sleeve and a plastic/aluminium lid).

- the packaging is allocated a target material in the recycling process.
As the further sorting (level 2) and preparation (level 3) of packaging is basically material-specific, for the further recycling process, the type of determining packaging material must be defined in terms of the understanding of the accepted material or the target material. According to [ZSVR 2022], in the case of tinplate or aluminium packaging or composite packaging containing metal (such as multilayer packaging with aluminium layers, aerosol cans, composite cans with tinplate bottoms, but not metallised packaging and cups with aluminium plates and LPB), the respective metal is always the target material for recycling. Otherwise, the target material is generally considered to be the packaging material with the largest weight share of the packaging. If, in exceptional cases, a material which is only used as a packaging aid, for closures or wrappings, for example, has the largest weight share, the target material is determined differently in accordance with the packaging material on which the packaging is based⁹ (for example, a cup, bag, can, bottle, tray or tube).

Due to the considerable variety and development dynamics in the design of packaging, it may be possible in individual cases that a recyclability assessment is appropriate which, due to particular information situations or circumstances¹⁰, diverges from the standard procedure. Divergences from the standard procedure are then to be shown and justified accordingly.

The following table summarises the criteria for assessing the recyclability and their relevance to the possible target materials.

⁹ Packaging component which forms the main part of the packaging and is designed to hold packaged goods. It is used for the partial or complete wrapping, and in its final state, forms an open or closed hollow container. (see DIN 55405).

¹⁰ During the assessment of packaging made of wood or ceramics, for example.

Table 4-1: Overview of criteria catalogue. X = criterion to be applied to corresponding target material.

Criterion	Abbreviation										
		PE	PS	PP	PET	LPB, PBC comp.	Tinplate / Fe	Aluminium	PBC	Glass	
Level 1 Allocation of the packaging to the collection system											
Can the intended collection system of the packaging be allocated by the consumer?	Collection system can be allocated	X	X	X	X	X	X	X	X	X	X
Level 2: Sorting capacity of mixed packaging collected											
Is the packaging large enough?	Minimum size	X	X	X	X	X		X			
Identifiability of tinplate packaging: Is the packaging magnetisable? (magnetising capacity) ¹⁾	Magnetising capacity	X	X	X	X	X	X				
Identifiability of Al packaging: Is the packaging sufficiently electrically conductive? (Conductivity) ¹⁾	Conductivity	X	X	X	X	X		X			
Identifiability of packaging made of plastic, LPB, PBC composite, PBC and glass: Is the packaging recognisable from its surface?	Surface characteristics	X	X	X	X	X			X ²	X ²	
Level 3 Suitability for mechanical recycling and provision of secondary products											
Can a high-quality form of recycling be expected for the packaging?	Extent to which the recycling method is high-quality	X	X	X	X	X	X	X	X	X	X
Does the packaging contain non-recyclable shares that can be separated during processing?	Separable, non-recyclable shares	X	X	X	X	X	X	X	X	X	X
Does the packaging introduce (non-removable) impurities with the risk of contaminating the recycled product and/or disrupting the recycling process?	Non-separable shares and/or impurities	X	X	X	X	X	X	X	X	X	X

¹⁾ Target material plastic and/or PBC composite (not LPB): test for identification on basis of TP and/or small Al shares

²⁾ Packaging made of glass and PBC are collected separately from the LWP mixture as mono-material. The identification of PBC (via NIR) and glass (via visual sorting) as target materials does not therefore take place within the scope of LWP sorting, but downstream in the actual mechanical recycling process. Notwithstanding this, the assessment of identifiability is formally allocated to level 2 for reasons of clarity. As a rule (for exceptions, see [ZSVR 2022] or Table 6-7), the identifiability or sorting capacity of packaging made of glass and PBC can be assumed to be given.

5 Level 1: Allocation of the packaging to the collection system

5.1 Can the intended collection system of the packaging be allocated by the consumer? (Collection system can be allocated)

Explanation

To ensure the recyclability during the sorting and preparation, the consumer is required to take the packaging to the designated collection system after use. In general, it is therefore necessary for the consumer to decide whether the packaging is intended for LWP, PBC or container glass collection¹¹. Under certain circumstances, packaging in which LWP materials (for example, plastics and aluminium) are combined with PBC can therefore lead to challenges with the allocation¹². This can be particularly the case with packaging designs in the form of compounds or in the case of specific packaging aids (for example, cardboard label sleeves for yogurt pots). Disposal instructions provide the possibility for supporting the consumer with their decision in the case of packaging designs that may potentially be difficult to allocate.

Operational implementation assessment

Table 5-1: Assessment of the “can be allocated to collection system” criterion

Aspect	Explanation
Technical information requirement for the assessment	Packaging materials, weight shares, target material (for definition, see section 4)
Assessment method, tool	Determination on the basis of the packaging sample provided. If the target material is not clearly identifiable, completion of appropriate laboratory analyses on the types of material used and their weight shares

¹¹ The separate collection of metallic packaging is also possible in some cities or districts

¹² In the case of combinations of LWP material (in most cases, closures) with container glass or possibly Fe metal, for the purposes of simplification, no difficulties are assumed for the allocation to the material-specific collection system.

Table 5-2: Assessment of the “can be allocated to collection system” criterion

Classification / assessment	Explanation Classification
Intended collection system for consumers can be allocated intuitively <u>without any problems</u>	Packaging only consists of the LWP materials plastic, aluminium, tinplate or paper and/or container glass. Paper packaging aids (labels) only account for a small weight share (significantly less than 20% by mass)
Intended collection system for consumers can be allocated intuitively to a <u>limited extent</u>	Packaging material is LPB or Packaging material is a PBC-based composite and/or Packaging material is plastic, and packaging aids made of PBC have a considerable weight share (significantly more than 20 mass %). The packaging contains printed information regarding the intended collection (in this case, simply printing a recycling symbol equivalent to the “Green Dot” is not sufficient).
The intended collection system is <u>difficult</u> for consumers to allocate intuitively	Packaging material is a PBC-based composite and/or Packaging material is plastic, and packaging aids made of PBC account for a considerable weight share of the packaging. The packaging does not contain printed instructions on its intended collection.
The intended collection system <u>cannot</u> be allocated on the part of the consumer	Packaging material is neither plastic, LPB, PBC composite, aluminium, tinplate nor paper and/or container glass

6 Level 2: Sorting capacity of mixed packaging (LWP) collected

6.1 Is the packaging large enough? (Minimum size)

Explanation

The minimum size of a piece of packaging is a key characteristic in terms of the successful sorting of mixed LWP. If the packaging falls below a minimum size, it is highly likely that it will be rejected in the first stages of the sorting, i.e. it will not be sorted to the required depth for high-quality recycling. An exception is ferrous metal packaging and/or packaging components (such as crown caps), which are usually removed from small material streams with a high degree of sorting success:

- The classification of the primary material into two to three size categories takes place using drum sieves¹³. Narrowing down the grain spectrum to a specific minimum and/or maximum is necessary to ensure that the subsequent sorting units are able to work efficiently. Packaging which falls below the minimum size can only be allocated to the correct target fraction to a limited degree.
- The air nozzle bar of an NIR sorting unit has a distance between each discharge blower (air nozzle) (see Figure 6-1). The nozzle distances are usually in a range of 12.5–37.5 mm. Packaging which is smaller than the nozzle spacing is less likely to be discharged; packaging of a sufficient minimum size is highly likely to be discharged.

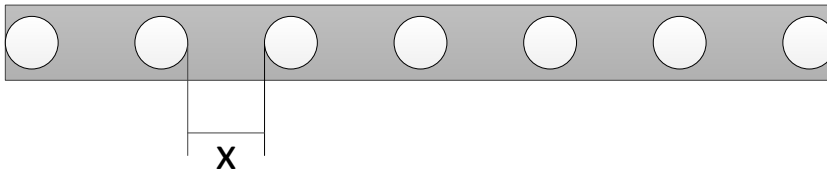

Figure 6-1: Schematic diagram of an NIR air nozzle bar with a nozzle spacing of 12.5–37.5 mm

The lower grain size in the classification (drum sieving) is usually in the range of 20 to 50 mm. Therefore, 20 mm is set as the required minimum size for the packaging, as this also allows for a separation using an NIR sorting unit.

¹³ Either a large drum sieve with two screen cross-sections or two drum sieves, each with one screen cross-section are used.

Operational implementation assessment

Table 6-1: Assessment of the minimum size criterion

Aspect	Explanation
Technical information requirement for the assessment	Size, dimensions of the packaging.
Assessment method, tool	Determination through visual observation of the packaging sample, supplemented with a laboratory test if required (laboratory test: the gauge of the packaging must not be able to pass through a round opening with a diameter of 20 mm)

Table 6-2: Assessment of the minimum size criterion

Classification / assessment	Explanation Classification
Packaging is of sufficient size	Packaging is larger than 20 mm in two dimensions
Packaging is <u>not</u> of sufficient size	Packaging is smaller than 20 mm in two dimensions

6.2 Identifiability of tinfoil packaging: Is the packaging magnetisable? (Magnetising capacity)

Explanation

Packaging that can be magnetised can be removed from the packaging stream with a high degree of separation efficiency and yield. In most cases, a magnetic separator is installed after the classification process above a conveyor belt or a discharge edge at a maximum distance of 1 m. To allow the packaging to be removed and enter the intended recycling path for iron packaging, it is necessary for it to have sufficient ferromagnetic properties.

Tinfoil (iron) is normally used for packaging, in the form of cans, for instance. Labels, coatings or protective layers made of plastics do not generally have a negative effect on the sorting with magnetic separators. It can be assumed that the iron share of the tinfoil packaging is usually sufficiently high and the magnetic separation is guaranteed.

Operational implementation assessment

Table 6-3: Assessment of the magnetising capacity criterion

Aspect	Explanation
Technical information requirement for the assessment	Magnetising capacity or Fe share
Assessment method, tool	<p>Magnetising capacity is a separation feature that enables a high degree of sorting success. If TP is the material with the largest weight share of the packaging, as a general rule it can be assumed that the packaging can be sorted and separated without restriction.</p> <p>For packaging with lower shares of TP (small shares, although TP is the target material), the identifiability must be estimated. If in doubt, carry out plant or laboratory tests.</p> <p>The following set-up is suggested for a laboratory experiment: A cuboid ferrite permanent magnet is to be used for the laboratory experiments. The dimensions of the magnet should total at least 10*10*5 cm. The magnet is placed at a distance of 5 cm ¹⁴ above the packaging to be tested. The packaging must be tested in different positions underneath the magnet. If the packaging is lifted by the magnet in all positions, the packaging is to be assessed as magnetisable.</p>

Table 6-4: Assessment of the magnetising capacity criterion

	Simplified assessment	Plant / Pilot plant trial
Classification / assessment	TP is the target material and material with the largest weight share in the packaging (e.g. can)	TP is the target material, although TP does not have the largest weight share in the packaging (composite containing metal)
Detection of TP possible without restriction.	No test required, as it is assumed that a detection is possible in all cases	Detection of TP takes place in all examined positions
Detection of TP limited or not possible	-	If the detection of TP only takes place in part of the possible positions to be examined, the <u>sorting behaviour of the packaging is assessed on the basis of the material with the largest weight share (for example, plastic or paper)</u>

6.3 Identifiability of AI packaging: Is the packaging sufficiently electrically conductive? (Conductivity)

Explanation

Based on the electrical conductivity of a piece of packaging, the specific production of a non-ferrous metal fraction is possible (especially aluminium). Eddy current separators are used to separate this fraction. For the precipitation, these make use of the formation of eddy currents in electrically-conductive materials in the presence of changing magnetic fields. In principle, it

¹⁴ Distance for the described laboratory magnet (10*10*5 cm). For other laboratory magnets, the distance may have to be adjusted.

is irrelevant as to whether the conductive layer (for example, aluminium film) is enclosed by other layers (PBC, plastic). In general, success of the outcome increases with the surface area and the layer thickness of the non-ferrous metal as well as the share of the Al mass in terms of the overall packaging. It is also important to distinguish between whether the packaging contains aluminium film, or whether it has only been vapour-deposited with aluminium¹⁵.

Commonplace packaging containing aluminium includes yogurt pot lids, vacuum packaging for coffee, aluminium films, aluminium tubes, pet food trays, empty tablet packaging (aluminium-plastic blisters) or coffee capsules. Aluminium can be the original target material of the packaging or, in combination with the target materials of plastic and PBC¹⁶ in particular, it may have a small share. If Al is used as both a target material and a small share, its identifiability must be checked on the basis of the conductivity.

Operational implementation assessment

Table 6-5: Assessment of the conductivity criterion

Aspect	Explanation
Technical information requirement for the assessment	Electrical conductivity or Al share
Assessment method, tool	<p>If Al is the material with the largest weight share of the packaging, it can be generally assumed that the packaging can be sorted using an eddy current separator.</p> <p>In the case of lower Al shares (small Al share, although Al is the target material), plant or pilot plant tests must be carried out in case of doubt. The eddy current separator must correspond to an eddy current separator used in an actual LWP plant operation in terms of the key setting parameters (see Figure 6.2). The packaging to be tested is to be tested in different positions on the eddy current separator. If the packaging progresses beyond the point of separation in all positions, the packaging is to be assessed as electrically conductive.</p>

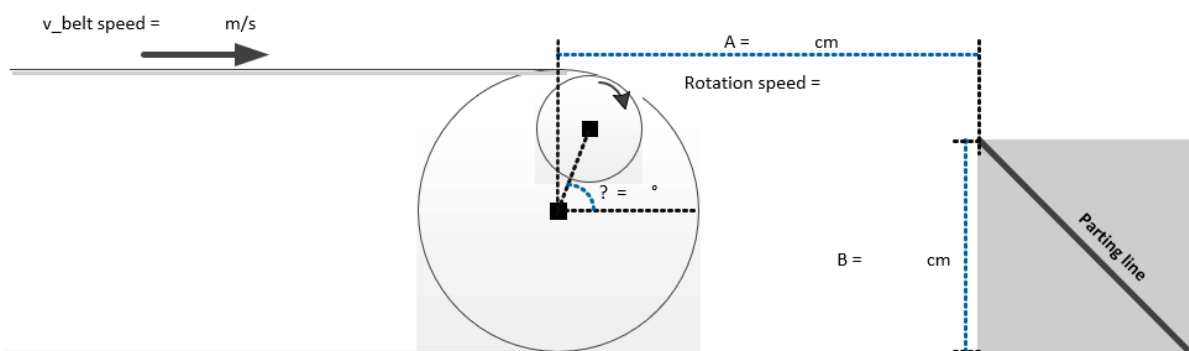

Figure 6-2: Sketch of an eddy current separator with eccentrically mounted pole wheel and the key adjustment parameters (belt speed, angle of the pole drum, rotational speed, distance and height of the point of separation)

¹⁵ Vapour-deposited aluminium layers have a high pore content, so their conductivity is significantly limited.

¹⁶ But not LPB, which is produced upstream in the sorting chain as a separate fraction through NIR detection

Table 6-6: Assessment of the electrical conductivity criterion

	Simplified assessment	Plant/ pilot plant trial
Classification / assessment	Al is the target material and the material with the largest weight share in the packaging (e.g. can)	Al is the target material, although Al does not have the largest weight share in the packaging (e.g. composite containing metal)
Detection of Al possible without restriction.	No test required, as it is assumed that a detection is possible in all cases	Detection of Al takes place in all possible positions to be examined
Detection of Al limited or not possible	-	If the detection of Al only takes place in part of the examined positions, the <u>sorting behaviour of the packaging is assessed on the basis of the material with the largest weight share (e.g. plastic or paper)</u>

6.4 Identifiability of packaging made of plastic, LPB, PBC composite and/or PBC and glass: Is the packaging recognisable from its surface? (Surface characteristics)

Explanation

The surface characteristics criterion is key to the identification of plastic packaging, liquid packaging board (LPB) and paper composites (PBC). Most sorting plants distinguish between different types of plastic (PET, PE, PP, PS, etc.) and their composites with the use of NIR (near infrared) measuring technology, and remove them from the waste stream with the use of compressed air. The conditions for a successful NIR sorting process depend on various factors:

- Detectability of the target material on the surface
 - Type of surface material
 - Structure and layer thicknesses of composite materials (multi-layer)
 - Surface colour
 - Reflection behaviour
- Several detectable materials have a share in the surface (for example, a bottle made of PE with a lid made of PP) and the position of the packaging on the sorting belt (in the case of flat packaging with a multi-layer structure in particular, different materials can be detected according to the side facing the separating unit)

The surface colour and its reflective behaviour are decisive factors that significantly influence the sorting capacity. Surfaces which are reflective or have a metallic coating reflect the near-infrared radiation non-specifically, so that a detection of the material is impossible. Dark or black materials absorb the near-infrared radiation. This serves to prevent a reflection towards the detector unit. The recognition of the material and the output as the target fraction is impossible. Plastics which are coated in this way or are dark-coloured cannot be transferred to the correct recycling path and end up in the sorting residues or mixed plastics fraction.

Packaging which consists of several materials also poses problems for the identification. In principle, a piece of packaging can be designed on a multilayer basis (different material layers) and/or with several packaging components, such as packaging aids. The NIR detection of packaging with multilayers is influenced by the layer structure, the respective layer thicknesses, the materials used and individual settings of the NIR sorting system. A complete coating with impurities could also, in principle, lead to a correct identification of the target material if the layer thickness of the impurities is sufficiently low and the reflection behaviour is favourable.

Ultimately, however, the points at which the surface measurements are taken is decisive. The probability of a correct allocation to the target fraction increases with the surface share of the target material. If more than 30% of the surface of the target material consists of impurities¹⁷, there is a high probability that a correct identification of the target material cannot take place. Labels, printing or wrappings can therefore have a negative effect on the NIR detectability of the target material if they are not made of the target material. Closure systems (lids, caps, screw caps, sealing films, pourers, dispensers, etc.) made of impurities can also prevent the packaging from being allocated to the correct target fraction. In both of the aforementioned cases, there is a risk that the material of the packaging aid will be detected. This also depends on the position of the packaging on the sorting belt (especially in the case of flat packaging) and on the technical specifications of the NIR separator.

Large, flat, flexible plastics (films) occupy a special position.

Flat packaging makes the identification of other packaging difficult or impossible, especially when it covers it. Plastic films are also more difficult to remove using the NIR technique, as the flight behaviour during the blowing out process is diffuse. Flexible plastics can also change their position on the NIR detection belt at high belt speeds. The targeted blowing out is no longer possible. To prevent these effects, large-scale flexible plastics are separated out at the beginning of the sorting process using an air separator and are usually fed in as a separate fraction for further recycling after the manual product control.

For this type of packaging, the identification and/or sorting can also be carried out with the weight per unit area instead of the NIR detection of the surface. As part of this assessment methodology, an output is assumed from an area of > DIN A4, regardless of the plant-specific equipment settings.

Packaging made of glass and PBC is collected separately from the LWP mixture as mono-material. The identification of PBC (via NIR) and glass (via visual sorting) as target materials does not therefore take place within the scope of LWP sorting, but according to the material-specific, separate collection in the actual mechanical recycling process. Notwithstanding this, the assessment of identifiability is formally allocated to level 2 for reasons of clarity. As a rule (for exceptions, see [Table 6-7]), the identifiability and/or sorting capacity of packaging made of glass and PBC can be assumed to be given.

¹⁷ Plastics Recyclers Europe: www.plasticsrecyclers.eu

Operational implementation assessment

Table 6-7: Assessment of the surface characteristic criterion

Aspect	Explanation
Technical information requirement for the assessment	<ol style="list-style-type: none"> 1. Colour and reflectivity of the surface/s 2. For different surface materials: Distribution of the surface in percentage (also, position dependency) 3. Special case of flexible plastics: Surface area, dimensions of the packaging.
Assessment method, tool	<p>According to [ZSVR 2022], an empirical examination of identifiability and separability in the form of trials is not generally required. Packaging characteristics which require examination of identifiability and separability through trials, however, are:</p> <p>Plastic packaging</p> <ul style="list-style-type: none"> • Large-area labelling (> 50% of the surface) with impurities, • Full-sleeve labelling (excluding full sleeves of PET hollow bodies – clear or light blue – where OPS, PET or PO sleeves are used) • Multilayer design (except: PE/ PP-EVOH or inner-walled and/or metallised in the centre layer) • Metallisation (except inside / metallised in the centre layer) • Dark colour design using carbon black-based dyes (also when used in interior layers) • Different types of plastic on the front and rear sides • Metal pigments applied over a large area (> 50% of the surface) (lacquering, coating or embossing) • Nets <p>LPB</p> <ul style="list-style-type: none"> • Design that deviates from the standard design (not wet-strengthened cardboard, PE ± aluminium) <p>PBC packaging and PBC composites</p> <ul style="list-style-type: none"> • lacquered surface (except for clear protective lacquers up to a lacquer thickness of ≤ 5 micrometres) • plastic-coated surface • black through-dyed with the use of carbon black-based dyes <p>Glass</p> <ul style="list-style-type: none"> • lack of transparency and/or translucency (detection with optical sorting units in the ultraviolet or visible light wave range) <p>The assessment takes place via</p> <ul style="list-style-type: none"> • an apparent assessment of whether packaging attributes are present that require examination (if not, the unrestricted identifiability of the packaging is assumed) • in the special case of flexible plastics: Determination by visual inspection and/or measurement of the packaging sample • Test to assess identifiability (with the availability of corresponding packaging attributes) <p>According to [ZSVR 2022], the examination is to be carried out with an operational detection unit. The following procedure is suggested for a test: The packaging is fed to the NIR separation unit over the course of at least 10 cycles, by being ejected or dropped onto the feed belt (the random feed position is intended to take the position of the packaging to be expected in reality into account), and the percentage allocation to the sorting fractions in which the packaging is sorted is determined over the course of all cycles.</p>

Table 6-8: Assessment of the surface characteristic criterion

Classification / assessment	Simplified assessment	Test (required if the attribute according to [ZVSR 2022 Annex 2] is available)
Detection and separability of target material possible without restriction.	There is <u>no</u> packaging attribute according to [ZVSR 2022 Annex 2 or <i>Table 6-7</i>], or the packaging has a surface area clearly >DIN A4 (special case of flexible plastic)	A correct allocation of the target material takes place in at least 95% of all cycles.
Detection and separability of target material restricted		A correct allocation of the target material takes place in 75% to 95% of all cycles.
Detection and separability of target material clearly restricted		A correct allocation of the target material takes place in 75% to 50% of all cycles.
Detection and separability of target material impossible		A correct allocation of the target material takes place in less than 50% of all cycles.

7 Level 3: Suitability for mechanical recycling and provision of secondary products

The starting point for the assessment in level 3 is that the packaging is generally sorted into the fraction which is intended for the target material.

In special cases, in the case of LWP materials for which the sorting capacity of the target material is not given, the actual sorting fraction to be expected for the packaging or its recycling method is to be assessed in level 3 instead of the fraction which is intended for the target material. The corresponding decision-making grid is shown in the following figure.

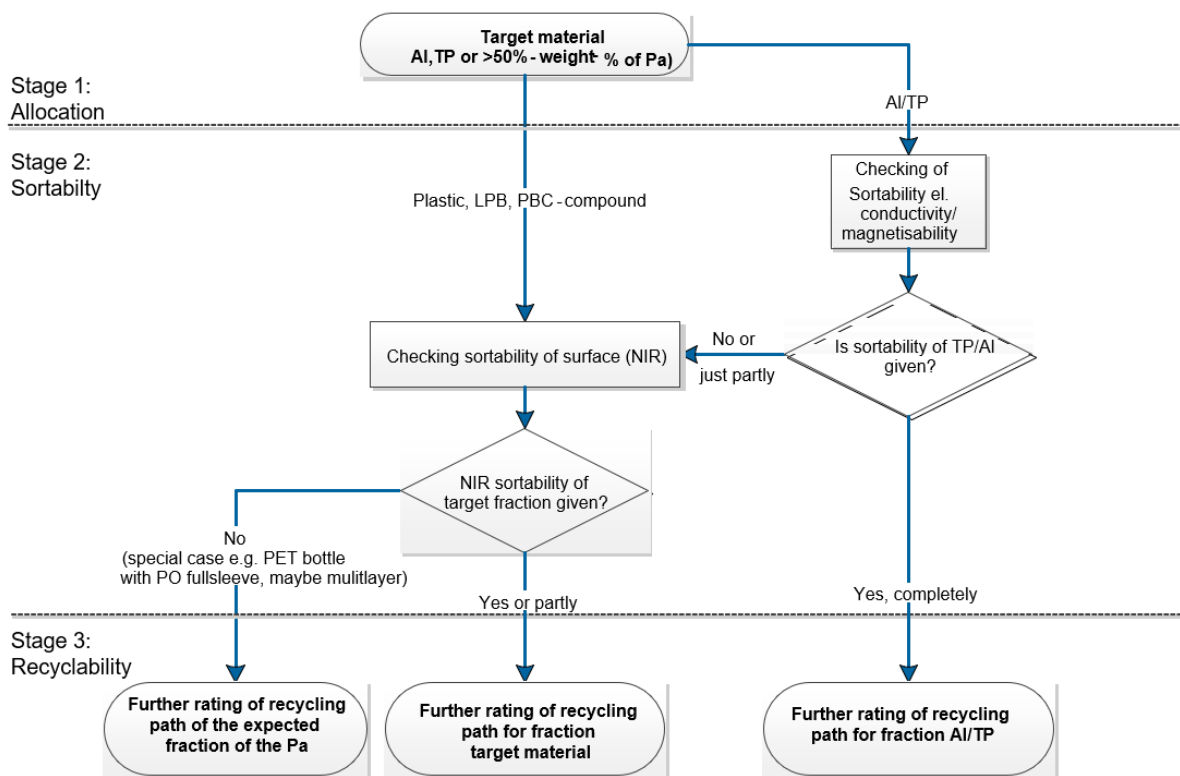

Figure 7-1: Selection of the recycling method for assessment in level 3 for mixed packaging (LWP).

7.1 Can a high-quality form of recycling be expected for the Packaging? (Quality of the recycling method)

The fractions to be yielded from the LWP sorting and pressed as baled goods, and the packaging collected separately on a material-specific basis from the PBC and container glass, are sent for recycling. The marketing depends strongly on the quality of the material and the current marketing prices. In the status quo, sorted plastics (PP, PE, PET, PS, films), metals, liquid packaging board, PBC and container glass, apart from non-material shares, are generally recycled mechanically and then returned as secondary products to the plastics processing industry or to aluminium, steel, glass and paper manufacturers.

The method presented here for assessing the recyclability prioritises high-quality mechanical preparation methods with a view to the potential reuse of the recycled products as a substitute for the original primary material. In terms of this method, packaging used for the purposes of energy recovery is generally classified as being non-recyclable.

The recyclability assessment is carried out in relation to the material-specific collection and recycling processes that are relevant in Germany today. Today, high-quality mechanical recycling is generally only available for certain packaging materials. These packaging materials are iron, aluminium, container glass, PBC, cardboard and the plastic types PE, PP, PS and PET (for example, transparent bottles¹⁸). For other packaging materials (for example, PVC, PLA), no recyclability can currently be assumed¹⁹.

Today, there are very few buyers for the mechanical recycling of sorted mixed fractions made from transparent PET bottles and other PET packaging materials (for example, trays, blister packs), as different types of PET are used which cannot be recycled together or can only be recycled together mechanically on an extremely limited basis.

These difficulties mean that at present, only PET bottles are sent for high-quality mechanical recycling, while other PET fractions (for example, PET trays) largely end up in the sorting residues and are sent for thermal energy recovery [Öko-Institut 2016].

The following table summarises the preparation methods which may be expected in the status quo and an assessment in terms of high-quality.

¹⁸ Rigid packaging made of PET, such as trays, is not currently recycled mechanically (<https://www.k-zeitung.de/falscher-pet-einsatz-das-kann-so-nicht-bleiben/150/1085/81998/>)

¹⁹ The quantities of packaging waste from biobased polymers (for instance, PLA/starch blends) in the LWP stream, for example, are still too small to carry out a generally possible but nonetheless uneconomical fraction and/or type-specific form of mechanical recycling.

Table 7-1: Overview of recycling methods

Sorting fraction	Recyclable material	Expected type of recycling in terms of recyclable material [ZSVR 2022]	Decomposition [ZSVR 2022]
PE, rigid, semi-rigid	HDPE (PO)	High-quality mechanical	Cartridges for sealants
PP, rigid, semi-rigid	PP (PO)	High-quality mechanical	Cartridges for sealants
rigid, semi-rigid PS	PS, rigid PE and PP share	Only high-quality mechanical to limited extent	foamed plastics incl. EPS products
Transparent PET bottles, clear or coloured (PET-A)	PET; PO from closures	High-quality mechanical	opaque PET bottles and other PET products
Other PET packaging (PET-A) such as trays, lids, cups and other thermoforms	(PET)	Predominantly energy recovery / only high-quality mechanical in individual cases	-
PE, large-format films ≥ DIN A4	LDPE (PO)	High-quality mechanical	Aluminium-vapourised plastics
Large-format PP films ≥DIN A4	PO	Only high-quality mechanical to limited extent	Aluminium-vapourised plastics
Flexible PE < DIN A4	PO	Only high-quality mechanical to limited extent	
Flexible PP < DIN A4	PO	Only high-quality mechanical to limited extent	
EPS	(PS)	Predominantly energy recovery / only high-quality mechanical in individual cases	
LPB (cardboard composites made of cardboard/PE or cardboard/aluminium/PE)	Fibrous material share	High-quality mechanical	Other items made of paper, cardboard, carton
Other fibre-based composite packaging (without metallic main component) (→ PBC from LWP) such as laminated folding boxes, composite cans, coated papers, paper cups coated on both sides, wrappers, etc.	Fibrous material share	Only high-quality mechanical to a limited extent ²⁰	Liquid packaging board, wax, paraffin, bitumen and oiled paper
PBC packaging, without composites such as corrugated board, folding boxes, paper bags	Fibrous material share	High-quality mechanical ²¹	Liquid packaging board, wax, paraffin, bitumen and oiled paper
Tinplate and thin sheet metal packaging as well as composites containing tinplate such as tin	Steel and Al share	High-quality mechanical	

²⁰ For packaging filled with liquid or paste contents, individual evidence must be submitted in accordance with the detailed provision in 4.2. [ZSVR 2022]

²¹ For packaging filled with liquid or paste contents, individual evidence must be submitted in accordance with the detailed provision in 4.2. [ZSVR 2022]

Sorting fraction	Recyclable material	Expected type of recycling in terms of recyclable material [ZVSR 2022]	Decomposition [ZVSR 2022]
cans, aerosol, varnish and paint cans, tinplate containers, composite cans with tinplate bottoms			
Aluminium packaging and aluminium-based composites (for example, aerosol cans, trays, tubes) or composite packaging containing aluminium film, blister packs for tablets, stand-up pouches, dry soup bags, tubes	Al and steel share	High-quality mechanical	
Container glass and glass packaging	Share of soda-lime glass; Steel and Al share from lids and closures	High-quality mechanical	Lead glass, non-processed safety glass, glass ceramics, lighting products, TV glass, quartz glass and other glass containing lead

Operational implementation assessment

Table 7-2: Assessment of the extent to which the recycling method is high-quality criterion

Aspect	Explanation
Technical information requirement for the assessment	Expected recycling method for the packaging
Assessment method, tool	Determination of the expected sorting fraction (see Figure 7-1) and allocation of an expected preparation method (see Table 7-1).

Table 7-3: Assessment of the extent to which the recycling method is high-quality criterion

Classification / assessment	Explanation Classification
Expected preparation method for the target material ²² of the packaging is high-quality mechanical	Sorting fraction films, PP, PE, LPB, non-ferrous metals, PET (transparent bottles) tinplate, PBC or container glass
Expected preparation method for the target material of the packaging is predominantly high-quality mechanical	<ul style="list-style-type: none"> • Rigid, semi-rigid PS • Large-format PP films ≥DIN A4 • Flexible PE < DIN A4 • Flexible PP < DIN A4
Expected preparation method for the target material of the packaging is only partly high-quality mechanical	<ul style="list-style-type: none"> • PBC from LWP
Expected preparation method for the target material of the packaging is only high-quality mechanical in individual cases and/or the preparation method for the target material of the packaging is exclusively for energy recovery	<ul style="list-style-type: none"> • Other PET packaging (PET-A) (exception in individual cases upon provision of proof) • EPS (exception in individual cases upon provision of proof) • Target material is <u>not</u> TP / Fe, aluminium, container glass, beverage carton, PBC, PE, PP, PS or PET or • Sorting residues are to be assumed as the expected fraction after sorting • Packaging excluded from a sorting fraction (see column 4 Table 7-1)

If, in individual cases, the existence of the infrastructure necessary for high-quality mechanical recycling and its use can be documented, an exception may apply. For the respective individual case, the documentation must include: Proof that the result of the recycling process is high value in terms of the minimum standard and proof that the recycling method was provided to an appropriate extent, as supported with a weighing slip, [ZSVR 2022].

²² In special cases, in the case of LWP materials for which the sorting capacity of the target material is not given, the actual sorting fraction to be expected for the packaging or its recycling method is to be assessed in level 3 instead of the fraction which is intended for the target material.

7.2 Packaging plastics (PE, PP, PS, PET)

7.2.1 Does the packaging contain non-recyclable shares that can be removed during the preparation steps? (Separable parts that cannot be recycled)

Explanation

During the preparation of standard packaging plastics, there are individual packaging components that are foreign to the material and interfere in the preparation process or can have a negative impact on the quality of the recycled product. However, some of these non-recyclable packaging shares can usually be removed in the various steps of the preparation process (washing, float and sink separation, melt extrusion).

- The washing usually takes place in aqueous medium. The purpose of the washing is to clean product of adhesions and to remove or detach labels, foreign materials and other unwanted components such as prints.
- Subsequently, a density separation (float and sink separation) of the previously crushed and washed packaging is usually carried out so that the requisite plastic fraction can be enriched further. With the use of water, plastic types with a density greater or less than 1 g/cm³ are separated from each other. During the preparation of polyolefins (density < 1 g/cm³), plastics and other materials with a density > 1 g/cm³ can be removed as a sink fraction. Density separation reaches its limits for plastic types with small density differences. Plastics with a similar density such as PP and PE, for example, cannot be separated from each other. In this case, special liquids with a density which is between those of the target plastics can be used. However, this is rarely practised. During the recycling of PET (> 1 g/cm³), float and sink separation can be used to separate and recycle closures in particular, which are mostly made of PE-HD. The crushed components of the closure then end up in the light fraction and are therefore removed from the non-floating PET. PS (> 1 g/cm³) is also obtained as a sinking fraction and freed from specifically lighter PO shares. Changing the density of the original packaging material through the use of blends and additive compounds, for instance, can result in the introduction of impurities into the target fraction of the separation step or lead to the rejection of types of plastic from the target fraction that are actually wanted.
- During the further preparation of plastic fractions, the focus is on obtaining re-granulates (without additives) or regenerates (with additives) in the remelting process. During the extrusion / melting process, the shares that have a lower melting temperature compared with the processing temperature are also transferred into the re-granulate. These can cause a deterioration in the characteristics of the product (see Section 7.2.2). Therefore, the processing of composite materials, blends and plastics with additive compounds is potentially problematic. Although higher melting components can be separated and discharged as residues with the use of melt filtration, they increase the cleaning workload for the filter screen and also lead to yield losses of the target material during the course of the filtration. Low-melting components, on the other hand, find their way into the recyclate and/or decompose beforehand, which leads to a deterioration of the mechanical and visual characteristics of the recyclate.

The following is an overview of substances that can be removed during the course of the aforementioned preparation steps.

Table 7-4: Overview of removable, non-recyclable packaging components (according to the European PET Bottle Platform and Plastics Recyclers Europe). Processing temperatures for new goods according to Saechtling²³.

	Washing of the crushed packaging components	Density separation of the crushed, washed packaging components	Remelting process of the target fraction from the density separation
PE-HD	Adhesives (water soluble below 60°C), paper labels	Packaging components, substances with a density > 1 g/cm ³ : PS, PET, PVC, EVA with aluminium	Packaging components, substances, etc. with a melting temperature higher than the processing temperature (approx. 160-220°C)
PE-LD	Adhesives (water soluble below 60°C), paper labels	Packaging components, substances with a density > 1 g/cm ³ : PS, PET, PVC, EVA with aluminium	Packaging components, substances, etc. with a melting temperature higher than the processing temperature (approx. 180-250°C)
PP	Adhesives (water-soluble below 80°C, paper labels)	Packaging components, substances with a density > 1 g/cm ³ : PS, PET, PVC, EVA with aluminium	Packaging components, substances, etc. with a melting temperature higher than the processing temperature (approx. 200-270°C)
PET, transparent bottles	Adhesives (water- or alkali-soluble in the temperature range 60 – 80°C), Paper labels	Packaging components, substances with a density < 1 g/cm ³ : PE, PP, foamed PET, OPP, EPS	Packaging components, substances, etc. with a melting temperature higher than the processing temperature (approx. 260-300°C)
PS	Adhesives (water soluble), paper labels	Packaging components, substances with a density < 1 g/cm ³ : PE, PP, foamed PET, OPP, EPS and with a density >1.08 g/cm ³ : PET, Al	Packaging components, substances, etc. with a melting temperature higher than the processing temperature (approx. 170-280°C)

The PO shares of transparent PET bottles (especially caps) can be removed for further recycling during the course of the PET preparation (floating fraction of the density separation). Accordingly, further recycling can also be assumed for rigid PE and PP shares that are separated during PS recycling.

In the case of the other light or heavy fractions from the density separation of other types of plastics, energy recovery is usually the only solution because of the heterogeneous composition (various types of plastics or non-plastic materials).

²³ Processing temperatures for re-granulates tend to be lower

Operational implementation assessment

Table 7-5: Assessment of the removable packaging components criterion

Aspect	Explanation
Technical information requirement for the assessment	<p>Description of packaging materials and packaging aids (including adhesives), in particular with regard to</p> <ul style="list-style-type: none"> • Materials used (including composition and shares), shares of mass, structure • Solubility of the adhesives used • Density of the materials used, melting point and/or glass transition temperature <p>through examinations or on the basis of valid secondary information</p>
Assessment method, tool	<p>If no valid secondary information (for example, manufacturer's data or processing experience on incompatibilities of aggregates, for example, non-removable shares with the target material) is available on the packaging materials, studies on the solubility, density and remelting behaviour on a laboratory scale are helpful:</p> <p>Assessment of the solubility of adhesives / labels: The procedure taken could, for example, be equivalent to the Quick Test QT504 of the European PET Bottle Platform (www.epbp.org/page/8/downloads). The description of the experiment applies to PET. For the other plastic fractions, the procedure can be carried out in an aqueous phase in the respective temperature ranges indicated along the same lines as the procedure described in Quick Test QT504.</p> <p>Assessment of swim and sink behaviour: The procedure taken could, for example, be equivalent to the Quick Test QT502 of the European PET Bottle Platform. Alternatively, a density determination of packaging components after crushing (only non-foamed materials) can be carried out according to DIN 1183-1.</p>

Table 7-6: Assessment of the removable non-recyclable packaging components criterion²⁴

Classification / assessment	Explanation Classification
Packaging does <u>not</u> contain any separable, non-recyclable shares	The secondary information on the Packaging and/or the examinations carried out prove that the Packaging does not contain any non-material and removable shares (packaging made from mono-material)
Packaging contains <u>small</u> shares	The secondary information on the Packaging and/or the examinations carried out prove that the Packaging contains non-material and removable shares up to a maximum of 10% by mass.
Packaging contains <u>relevant</u> shares	The secondary information on the Packaging and/or the examinations carried out prove that the Packaging contains non-material and removable shares of between 10% and a maximum of 30% by mass.
Packaging contains <u>significant</u> shares	The secondary information on the Packaging and/or the examinations carried out prove that the Packaging contains non-material and removable shares of between 30% and a maximum of 50% by mass.
Packaging contains <u>large</u> shares	The secondary information on the Packaging and/or the examinations carried out prove that the Packaging contains non-material and removable shares of more than 50% by mass.
Packaging is completely removed	The secondary information on the Packaging and/or the examinations carried out prove that the Packaging has been changed in terms of its characteristics (e.g. density), for example, by non-removable non-material shares (e.g. additive compounds or composites), in such a way that it is completely removed.

7.2.2 Does the packaging introduce (non-separable) impurities with the risk of contaminating the recycled product and/or disrupting the recycling process? (Impurities with risks)

Explanation

In terms of this methodology, substances with a **lower risk of contamination** are those substances in the packaging which, as a rule, do not have a significantly negative impact on the visual, mechanical or other characteristics of the recyclate and therefore on its marketability, depending on its concentration. The recyclate only has minor limitations in terms of its processability and area of downstream application. Residual contents in the packaging to be recycled also have the potential to increase the workload required for the recycling process. The limited capacity for a piece of packaging to be completely emptied is therefore assessed in terms of potential impurity with a low risk of contamination.

Substances with a **significant risk of contamination** are substances in the packaging which, partially depending on the concentration, have such a significant negative impact on the visual and mechanical properties that the product expected from the preparation process may no longer be marketable and can only be used for the purpose of energy recovery. The recyclate then has considerable limitations in terms of its processability and area of downstream application.

²⁴ PO shares from PET preparation are not taken into account as removable fractions, but as recyclable shares

The following table provides a simplified and non-exhaustive list of the typical impurities. The information is largely from the recommendations of [ZVSR 2022], Recyclclass²⁵ and [APR 2021]. The information in Table 7-7 provides an estimate of the process disturbances and/or impurities which are, in reality, to be expected for the materials mentioned. A specific assessment would generally require specific examinations. For some specific contaminations (according to [ZVSR 2022] and [APR 2021]), the recyclability of the packaging can generally be excluded.²⁶

Incompatibility with recycling due to limited emptying of plastic packaging

Residual contents of special filling goods that remain in the packaging after use can increase the efforts for the recycling process of the packaging. For the contents silicones, acrylates, polyurethanes and other cross-linking substances, waxes and paraffins as well as bituminous compounds (selection according to [ZSVR 2022]), potentially limited emptying of residues of plastic packaging is therefore rated as contamination.

So far, relevant aspects that have to be taken into account for a specific evaluation of the emptying of packaging, such as "intended emptying" or a "minimum quantity threshold for product residues" have not yet been specified within the framework of the minimum standard. Until then, according to the minimum standard, the contents for plastic packaging silicones, acrylates, polyurethanes and other cross-linking substances, waxes and paraffins as well as bituminous masses are assessed as incompatibility with recycling.

For the time being, the assessment will be made in general and only based on the type of filling goods. Not considered are

- the characteristics of the contents (e.g. solid, liquid, viscous),
- amount of remaining content or
- Characteristics of the packaging design that hamper emptying

²⁵ <https://recyclclass.eu/recyclclass/design-for-recycling-guidelines>

²⁶ According to [ZSVR 2021], individual proof must be provided for a deviating determination of harmlessness regarding the recyclability of incompatible substances.

Target material	Low risk	High risk	Non-recyclable [ZVSR 2022]
Film and/or LDPE (>A4) and flexible PE (<A4)	<p>Packaging material: Multi-layer with <5% PP</p> <p>Barriers: <5% EVOH, metallised barrier layers</p> <p>Packaging components: PP-, PBC</p> <p>Colours /prints: Prints <50% (transparent films) Prints >50% (coloured films)</p>	<p>Packaging material: Multilayer PE/PP with >5% PP</p> <p>Barriers: >5% EVOH</p> <p>Packaging components: Metallised labels, all other materials with density <1g/cm³</p> <p>Colours / prints: Prints >50% (transparent films), bleeding colours, toxic, hazardous inks</p>	<p>Fibre-based labels if the cellulose share cannot be removed by means of cold washing;</p> <p>PA layers (excluding nylon 6 or co-polyamide 6-66 in coextruded PE/PA films without EVOH, combined with MAH-grafted PE as an adhesive promoter at a ratio of at least 0.5 g of adhesive per 1 g of PA);</p> <p>PE-X components;</p> <p>PVDC layers;</p> <p>other non-PE polymeric layers (excluding adhesion promoters, adhesives, PP, EVA and EVOH),</p> <p>non-polymeric layers (excluding SiOx/AlOx/metallisations).</p> <p>[APR 2021]: PVC</p>
Flexible PP <A4	<p>Packaging material: Multi-layer with PE</p> <p>Barriers: EVOH, metallised barrier layers</p> <p>Packaging components: PP-, PBC</p> <p>Colours /prints: Prints <50% (transparent films) Prints >50% (coloured films)</p>	<p>Packaging components: Metallised labels, all other materials with density <1g/cm³</p> <p>Adhesives: non-soluble</p> <p>Colours / prints: Prints >50% (transparent films), bleeding colours, toxic, hazardous inks,</p>	<p>Adhesive cellulosic labels that cannot be removed under cold wash conditions.</p> <p>PA barrier layers, PVDC barrier layers, other non-PE polymer layers (except for adhesives, bonding agents, PP, EVA and EVOH), non-polymer layers (except SiOx/AlOx/metallisation)</p> <p>[APR 2021]: PVC, PVDC layer</p>

Table 7-7: Simplified overview of impurities with their potential risk (according to [ZVSR 2022], <https://recyclclass.eu/recyclclass/design-for-recycling-guidelines> [APR 2021], also visit this page for more detailed information on other packaging materials).

Target material	Low risk	High risk	Non-recyclable [ZVSR 2022]
Rigid HDPE	<p>Barriers: EVOH < 1%²⁷</p> <p>Packaging components: (e.g. caps, labels, closures): PP > 8%²⁸;</p> <p>Colours / prints: direct printing (coloured containers)</p>	<p>Packaging material: Multilayer HDPE + (PLA, PVC, PS, PET, PETG)</p> <p>Barriers: EVOH > 1%; Aluminium</p> <p>Packaging components: Metallisation and/or Al, PVC; filmed paper</p> <p>Colours / prints: bleeding colours, toxic, hazardous inks, direct printing (colourless containers),</p>	<p>Silicone components</p> <p>Components of foamed non-thermoplastic elastomers</p> <p>Fibre-based labels if the cellulose share cannot be removed by means of cold washing;</p> <p>PET sleeves with a density < 1g/cm³</p> <p>PA barriers; PE-X components, PVDC barriers</p> <p>Non-PO plastics with a density < 1 g/cm³</p> <p>[APR 2021]: Labels with PLA combined with non-water soluble adhesives</p>
Rigid PP	<p>Barriers: EVOH < 1%²⁹</p> <p>Packaging components: (e.g. caps, labels closures): PE > 8%³⁰</p> <p>Colours / prints: direct printing (coloured containers)</p>	<p>Packaging material: Multilayer HDPE + (PLA, PVC, PS, PET, PETG)</p> <p>Barriers: EVOH > 1%; Aluminium</p> <p>Packaging components: Metallisation, Al, PVC,</p> <p>Adhesives: non soluble</p> <p>Colours / prints: bleeding colours, toxic, hazardous inks, direct printing (colourless containers),</p>	<p>Silicone components</p> <p>Components of foamed non-thermoplastic elastomers</p> <p>Fibre-based labels if the cellulose share cannot be removed by means of cold washing;</p> <p>PET sleeves with a density < 1g/cm³</p> <p>PA barriers; PE-X components, PVDC barriers</p> <p>Non-PO plastics with a density < 1 g/cm³</p> <p>[APR 2021]: Labels with PVC, PLA combined with non-water soluble adhesives</p>
Rigid PS	<p>Barriers: EVOH</p> <p>Colours / prints: Prints < 50%</p>	<p>Barriers: PA, PVDC</p> <p>Colours / prints: Prints > 50</p>	<p>Foreign plastics or multilayers of density class Density 1.0 – 1.08 g/cm³</p> <p>Fibre-based labels if the cellulose share cannot be removed by means of cold washing;</p>

²⁷ Apart from EVOH > 6.0% in combination with PE-g-MAH tie layers (MAH > 0.1%) and EVOH to tie layers ratio ≤ 2 (<https://recyclclass.eu/de/novel-findings-for-functional-barriers-in-hdpe-containers/>)

²⁸ Assumption based on ISD information.

Target material	Low risk	High risk	Non-recyclable [ZVSR 2022]
Transparent PET bottles	<p>Additive compounds, filler materials: AA-/UV blockers, O₂ absorbers, brighteners</p> <p>Labels: lightly metallised labels, hot melts</p> <p>Colours / prints: Direct printing with production code, BBD</p>	<p>Colours: transparent colours except “light-blue”, opaque, fluorescent, metallic bottle colour</p> <p>Additive compounds, filler materials: bio- / oxo- / photo-chemically-degradable additive compounds, nanocomposites</p> <p>Labels: heavily metallised labels, pulpable paper labels</p> <p>Adhesives: non-soluble</p> <p>Colours / prints: Printing with bleeding colours, toxic, hazardous inks, direct printing; PET with water-soluble colour</p>	<p>PET-G components; POM components; PVC components</p> <p>EVOH barrier layers; PA monolayer barrier layers (only if bottle is colourless and “light blue”), other blended barriers;</p> <p>PVC labels/sleeves, PS labels/sleeves, PET-G labels/sleeves</p> <p>Use of PA additive compounds (only if bottle is colourless and “light blue”);</p> <p>Non-removable (washable) adhesive applications (in water or alkaline at 80°C), non-magnetic metals</p> <p>Elastomer components with a density > 1 g/cm³ 3;</p> <p>Direct printing (apart from production code and MHD)</p> <p>[APR 2021]: Packaging components (labels, dosing products, etc.) with PVC and PLA</p>
PO	n. a.	n. a.	<p>Silicone components;</p> <p>foamed non-thermoplastic elastomers with a density < 1 g/cm³;</p> <p>foamed non-polyolefin components</p> <p>Fibre-based labels if the cellulose share cannot be removed by means of cold washing;</p>

²⁹ Exception of analogue dimensionally-stable HDPE

³⁰ Assumption based on ISD information.

Operational implementation assessment

Table 7-8: Assessment of the impurities with risks criterion.

Aspect	Explanation
Technical information requirement for the assessment	<p>Potential contaminations (for details, see https://recyclclass.eu/recyclclass/design-for-recycling-guidelines, [ZSVR 2022] [APR 2021]) shown in simplified form Table 7-7 in the packaging. In the case of doubt, further examinations and research on possible product / process risks of non-removable material combinations, adhesives, additive compounds, etc.</p> <p>Assessment of the potential capacity of the packaging to be completely emptied, or examinations by the distributors according to the Recyclclass method (easy-to-empty index)</p> <p>Type of content: Silicones, acrylates, polyurethanes and other cross-linking substances, waxes and paraffins as well as bituminous compounds</p>
Assessment method, tool	Laboratory testing with appropriate analytics (for example, DSC, micro-tome sections, filler material analysis: TGA (thermal gravimetric analysis) or solvent-based polymer digestion (IVV method).

Table 7-9: Assessment of the impurities with risks criterion.

Classification / assessment	Explanation Classification
Packaging does not introduce any unwanted impurities into the product or recycling process	No unwanted impurity that cannot be removed
Packaging introduces unwanted impurities with a low risk of contamination for the recycling product and/or process	The Packaging contains components with a low risk of contamination that cannot be removed in the preparation process (differentiated assessment according to the number of types of impurities).
Packaging introduces unwanted impurities with a high risk of contamination for the recycling product and/or process	The Packaging contains components with a high risk of contamination that cannot be removed in the preceding preparation process (differentiated assessment according to the number of types of impurities).
Packaging has unwanted impurities that preclude a recyclability	The Packaging contains components for which the recyclability of the packaging can be ruled out across the board, regardless of whether these can be removed in the preceding preparation process.

In addition, residual contents of the product that may enter the recycling processes due to the limited capacity of the packaging to be completely emptied are assessed as a low-risk impurity.

7.3 PBC packaging, PBC composite and LPB

7.3.1 Does the packaging contain non-recyclable shares that are separated during the processing steps? (separable packaging components)

Explanation

The objective of recycling PBC packaging is to recover the fibrous material share from the packaging through defiberability. PBC packaging is treated in a pulper to break down the fibres. During this process, not only are remnants of the filling material removed, but also product

adhesions and any adhesive labels. Unwanted shares which can be removed during the preparation steps are recyclable adhesives and printing inks, wet-strength papers, non-material closure systems or staples, as well as EPS or plastic films and fibre components which cannot be broken down during the pulping process. When the fibre slurry is pressed through the screening system, all the substances that have not dissolved in the previous pulping step are usually removed and do not therefore have a negative effect on the material. This is always associated with a loss of fibre material, however. Additionally, non-paper substances can pass into the aqueous phase.

Compared with the recycling of PBC packaging, the pulping of LPB and other paper composite materials requires a special process with higher pulping times and a greater use of energy as well as a more complex reject line.

Non-recyclable, removable fractions are known as unwanted materials in recycled paper. They are classified as

- Non-paper components such as metals, plastics, synthetic materials, etc., and
- Non-paper substances which pass into the aqueous phase (water-soluble, colloiddally dissolved or finely dispersed)
- Paper, cardboard and cardboard packaging which is unsuitable as a raw material for normal production (for example, composites of paper with plastic and/or aluminium, wet-strength papers, papers containing wax, lacquered papers).

Operational implementation assessment

Table 7-10: Assessment of the “removable packaging components” criterion

Aspect	Explanation
Technical information requirement for the assessment	Description of packaging materials and all packaging aids (including adhesives), in particular with regard to <ul style="list-style-type: none"> • Materials used (including composition and shares), mass shares, construction • Share of unwanted materials
Assessment method, tool	Determination of the non-paper product components (incl. substances which pass into the aqueous phase) and the pulping capacity according to the PTS method PTS-RH 025/2022 or Aticelca/ 4Evergreen). The particular process conditions during the recycling of paper composites and LPB which are necessary for the recovery the fibre content are to be taken into account.

Assessment analogous to Table 7-6.

7.3.2 Does the packaging introduce (non-separable) impurities with the risk of contaminating the recycled product or disrupting the recycling process? (Impurities with risks)

Explanation

Impurities with a relatively low risk

During the production of recycled paper, depending on the target product, visual in-homogeneities are to be avoided. No impurities should be introduced into the product which could be perceived as dirt specks or other visual discrepancies in the paper web.

Moreover, components that are sticky, fragmented into small components and can clump together again (stickies) are also unwanted. Larger stickies (over 2 mm in equivalent circular diameter) can be separated using the stock preparation processes. Smaller stickies, however, can lead to deposits on the components of the paper web guiding machine, which cause paper web breaks and production downtimes.

Impurities with a significant risk

Impurities with a significant risk of negatively affecting the paper fibres are all substances that render the paper fibres unusable for reuse. These include wet strength and non-soluble dispersing adhesives.

The European Printing Ink Association (EuPIA) has issued a list³¹ of excluded substances and materials that should no longer be used due to their harmful nature. Components on the EUPIA list are not to be expected in packaging. A general examination can be dispensed with.

During the use of wet strength agents, impregnating agents, waxes, etc. as well as paper and cardboard coated on both sides or metallised (except for liquid packaging board) as well as fibre-based composite packaging and PBC-packaging for fluid and pasty contents in general it is necessary to determine the recyclability, according to the PTS method PTS-RH 025/2022 or Aticelca/ 4Evergreen, for example.

The following overview summarises impurities with a potentially low or significant risk for the production of recycled fibres.

Table 7-11: Overview of impurities with potential risk

	Low risk	Non-recyclable [ZSVR 2022]
PBC, LPB, PBC composite	<p>Assessment according to PTS method PTS-RH 025/2022:</p> <ul style="list-style-type: none"> limited recyclability due to visual inhomogeneity in the processed material the product is recyclable, but requires improvement in terms of the product configuration due to low its limited pulping capacity 	<p>Non-water soluble or non-redispersible adhesive applications and polymeric thermoplastic dispersion coatings unless it is proven that they do not lead to incompatibilities in the recycle. The exceptions for hotmelt referred to in the EPRC scorecard³² apply (adhesive softening temperature (according to R&B): ≥ 68 °C, layer thickness (non-reactive adhesive): ≥ 120 μm, layer thickness (reactive adhesive): ≥ 60 μm, horizontal dimensions of the application (in each direction): ≥ 1.6 mm).</p> <p>Assessment according to PTS Method PTS-RH 025/2022:</p> <ul style="list-style-type: none"> non-recyclable due to adhesive impurities Cannot be recycled effectively in paper recycling processes due to insufficient pulping capacity

³¹ EuPIA Exclusion List for Printing Inks and related Products

³² www.paperforrecycling.eu/download/882.

Operational implementation assessment

Table 7-12: Assessment of the “impurities with risks” criterion

Aspect	Explanation
Technical information requirement for the assessment	Potential recycling incompatibilities in the packaging
Assessment method, tool	Examination according to method PTS-RH 025/2022 <ul style="list-style-type: none"> • Determination of the pulping behaviour and share of unwanted materials (incl. substances which pass into the aqueous phase) • Examination for adhesive impurities or optical inhomogeneities

Assessment analogous to Table 7-9.

7.4 Tinplate and non-ferrous metals

7.4.1 Does the packaging contain non-recyclable shares that can be separated during the preparation steps? (separable packaging components)

Explanation

In the case of TP packaging, the material cycle for the iron content of the packaging is almost completely closed during the recycling process. However, losses of non-ferrous metals or organic compounds, for example, occur due to the preparation method (melting process). Specifically, these packaging components are labels, coatings with tin (tinplate), an enamel layer, or other inorganic and organic materials³³.

During the recycling of aluminium packaging, the share of organic components (paper or plastic labels) must be deducted from the recyclability, as these are pyrolysed.

Table 7-13: Overview of removable, unwanted packaging components

	Non-material components whose separation takes place in the melting or pyrolysis process
Tinplate	Aluminium, silicon, organic packaging components (plastic, PBC)
Aluminium	Organic packaging components (plastic, PBC)

Operational implementation assessment

Table 7-14: Assessment of the “removable packaging components” criterion

Aspect	Explanation
Technical information requirement for the assessment	Description of packaging materials and all packaging aids, in particular with regard to <ul style="list-style-type: none"> Materials used (including composition and shares), shares of mass, structure through examinations or on the basis of valid secondary information
Assessment method, tool	Dismantling of the packaging and possible determination of the annealing loss (DIN 15169). Expert assessment based on packaging information and/or packaging analysis

Assessment analogous to Table 7-6.

7.4.2 Does the packaging introduce (non-separable) impurities with the risk of contaminating the recycled product and/or disrupting the recycling process? (Impurities with risks)

Explanation

Impurities with a low risk

The type and share of unwanted packaging components depend on the area of application of the recycled product.

In principle, Fe packaging can contain inorganic packaging components such as copper, which forms an alloy with iron in the preparation process. The concentration of the alloy components

³³ These are oxidised as losses during melting in the blast furnace or the oxygen converter, and the metallic compounds are then separated out via the slag.

and the subsequent intended use require either an addition or dilution of the melt by metallic elements that are required in each case.

During the recycling of aluminium beverage cans, even low concentrations of copper (0.2 mass %) and silicon (0.3 mass %) are to be considered as unwanted. During the recycling of other aluminium packaging, higher tolerance limits (copper: 2.5 mass %; silicon: 1 mass %) apply. Here, too, pure aluminium is added until the required alloy is obtained [Erdmann et al., 2009].

Table 7-15: Overview of impurities with risk

	Impurities with a low risk of contamination of the product
Tinplate	Copper
Aluminium	Iron, silicon, copper

In addition, residual contents of the product that may enter the recycling processes due to the limited capacity of the packaging to be completely emptied are assessed as a low-risk impurity.

Operational implementation assessment

Table 7-16: Assessment of the impurities with risks criterion

Aspect	Explanation
Technical information requirement for the assessment	Potential contamination (see Table 7-15) in the packaging
Assessment method, tool	Expert assessment based on packaging information and/or packaging analysis

Assessment analogous to Table 7-9.

7.5 Container glass

7.5.1 Does the packaging contain non-recyclable shares that can be separated during the preparation steps? (separable packaging components)

Explanation

In the case of container glass packaging, the material cycle for the glass content of the packaging is almost completely closed during the preparation process. During the preparation process, non-material packaging aids (e.g. labels) are removed which, with the exception of metallic closures, are not recycled mechanically. Furthermore, specific packaging design can reduce the recyclable glass share partially or completely.

Table 7-17: Overview of removable, unwanted packaging components

	Non-material components that are removed during preparation
Container glass	Packaging aids such as closures, labels For removable metallic components such as from closures, a mechanical recycling may be assumed

Table 7-18: Overview of interfering packaging components reducing the recyclable glass share

	Non-material components which reduce recyclable glass share
Container glass	In the case of glass packaging with adhesive labels made from plastic, the glass share covered by these labels cannot be classified as recyclable content if the adhesive labels are waterproof/hydrophobic. With demijohns, i.e. bottles covered with a basket, the glass share is to be considered completely lost.

Operational implementation assessment

Table 7-19: Assessment of the “removable packaging components” criterion

Aspect	Explanation
Technical information requirement for the assessment	Description of packaging materials and all packaging aids, in particular with regard to <ul style="list-style-type: none"> Materials used (including composition and shares), shares of mass, structure through examinations or on the basis of valid secondary information
Assessment method, tool	Dismantling of the packaging and possible determination of the annealing loss (DIN 15169) Expert assessment based on packaging information and/or packaging analysis

Assessment analogous to Table 7-6.

7.5.2 Does the packaging introduce (non-separable) impurities with the risk of contaminating the recycled product and/or disrupting the recycling process? (Impurities with risks)

Explanation

Impurities with a significant risk

In the case of container glass, the introduction of lead oxide must be prevented, as the visual characteristics of the fragments and/or the new glass product are changed. Borosilicate glass interferes with the recycling of container glass because boron and aluminium oxides change the properties of normal glass. However, these glasses are not used in the field of container glass and/or are mainly used in the chemical industry. Metals such as lead, tin and iron (wrappings on champagne and wine bottles) have a corrosive effect on the melting tanks. Even very low concentrations of chrome iron, cobalt and copper can lead to a discolouration of the molten glass.

During the recycling of container glass, any inclusions in the glass (brackets for fixing the lid) or applications on the glass made of metal that cannot be removed by breaking are also problematic, as these get into the molten glass. There, they form inclusions in the glass, which can weaken the glass structure and lead to breakage. Aluminium caps (screw caps) that get into the molten glass lead to the formation of silicon that forms inclusions that weaken the glass structure. Ceramics, porcelain and earthenware do not dissolve in the melt. Inclusions form, which lead to breakage due to stresses in the glass.

Crystal glass packaging containing lead is not recyclable [ZSVR 2022].

The following overview summarises the possible impurities in container glass recycling.

Table 7-20: Overview of impurities with risk

	Impurities with a potentially significant risk	Non-recyclable [ZVSR 2022]
Container glass	Lead oxide, borosilicate glasses, chrome iron, copper, cobalt Inclusions and applications made of metals or plastic that cannot be removed	Crystal glass packaging with lead borosilicate glass; glass packaging with ceramic components; glass packaging with metal nets; swing tops with non-ferromagnetic metal shares only.

Operational implementation assessment

Table 7-21: Assessment of the “impurities with risks” criterion

Aspect	Explanation
Technical information requirement for the assessment	Potential contamination (see Table 7-20) in the packaging
Assessment method, tool	Expert assessment based on packaging information and/or packaging analysis

Assessment analogous to Table 7-9.

8 Quantitative recyclability assessment

The quantitative assessment of the recyclability of packaging is carried out in the framework of a scoring model using scoring points. The starting point for the assessment are the criteria for assessing the recyclability (Sections 5 to 0). A percentage weighting is specified for the assessment criteria in the framework of the scoring model (see Table 8-2), which is determined independently of the consideration of an individual piece of packaging.

The quantitative recyclability assessment is carried out in the following steps

- Based on the explanations in the Sections 5 to 7, the degree of fulfilment for the individual assessment criteria can initially be assessed qualitatively for the packaging to be examined.
- Based on the qualitative assessment of the degree of fulfilment of the packaging to be examined, a graded quantitative assessment (grading) between 20 (best assessment – level 1) and 0 or KO (worst assessment – level 5) is carried out for each assessment criterion. The underlying scaling is shown in Table 8-1.
- Multiplying the criteria-specific assessment of the packaging by the corresponding weighting for the respective criterion results in an individual scoring for each criterion.
- By adding up all the individual scores, the overall score for recyclability is obtained.

Table 8-1: Scoring model for quantitative assessment of recyclability.

Criteria	Scaling (Assessment in points)				
	Level 1	Level 2	Level 3	Level 4	Level 5
	20	15	10	5	0
Stage 1: Allocation of packaging to the correct disposal system					
Collection matchable	Intended collection system for consumers can be allocated intuitively <u>without any problems</u>	Intended collection system for consumers can be allocated intuitively to a <u>limited extent</u>	-	The intended collection system is <u>difficult</u> for consumers to allocate intuitively	-
					The intended collection system cannot be allocated on the part of the consumer
Level 2: Sorting capacity of mixed packaging (LWP) collected					
Minimum size	Pa is of sufficient size (significant >20mm)	-	-	Pa is <u>not</u> of sufficient size (significant <20mm)	-
Identifiability / separability					
Tinplate (Magnetisability)	Detection and separation of TP possible <u>without restriction</u>	-	-	-	-
Aluminium (Conductivity)	Detection and separation of Al possible <u>without restriction</u>	-	-	-	-
Plastic, LPB, PBC composite, PBC, glas (Surface characteristics)	Detection/ separability of target material possible <u>without restriction</u> , or special case <u>flexible plastic</u>	Detection/ separability of target material <u>restricted</u>	Detection/ separability of target material <u>clearly restricted</u>	-	Detection/ separability of target material <u>impossible</u>
Level 3: Suitability for mechanical recycling and provision of secondary products					
Quality of recycling method	Expected preparation method for the target material of the packaging is <u>high-value mechanical</u>	Expected preparation method for the target material of the packaging is <u>pre-dominantly high-value mechanical</u>	Expected preparation method for the target material of the packaging is only <u>partly high-value mechanical</u>	-	Expected preparation method for target material is only <u>high-value mechanical in individual cases</u> and/or exclusively for <u>energy recovery</u>
Separable parts that cannot be recycled	Packaging does <u>not</u> contain any separable, non-recyclable shares	Packaging contains <u>small</u> shares (< 10 mass-%)	Packaging contains <u>relevant</u> shares (> 10 mass-% and < 30 %)	Packaging contains <u>significant</u> shares (> 30 mass-% and <50 %)	Packaging is completely removed
Non-separable components, impurities	Packaging does <u>not</u> introduce any unwanted impurities into the product or recycling process	Packaging introduces unwanted impurities with a low risk of contamination for the recycling product and/or process		Packaging introduces unwanted impurities with a high risk of contamination for the recycling product and/or process	Packaging has unwanted impurities that preclude a recyclability

The recyclability of the packaging is therefore measured according to the number of scoring points achieved. It should be noted that the scoring points and/or their % share of the maximum score do not allow for the conclusion to be drawn as to what percentage mass share of the original packaging could actually be available as a secondary product after the recycling. If the assessment is 0 points (level 5) for one criterion, the assessment of the other criteria and the determination of recyclability continues as described. On the other hand, if a criterion is assessed at KO in level 5, it must be assumed that the packaging is not recyclable and must therefore be assessed as non-recyclable. To allow for the identification of potentials for the improved recyclability for packaging of this kind in particular, a conditional assessment is made for the assessment levels to which the KO criterion is not allocated.

Packaging made of glass, PBC and TP receives the best overall assessment for the minimum size criterion,

- a packaging made of glass and PBC is collected on a material-specific basis and thus a LWP sorting process, to which the criterion of minimum size refers, is not intended and/or
- an identification of small TP packaging from the LWP mixture is also assumed.

Packaging whose TP and/or the small AI share is not sufficient for unrestricted identification on the basis of magnetising capacity or conductivity, the sorting behaviour of the packaging is assessed on the basis of the material with the greatest weight share (for example, plastic or paper) (also see Table 6-4)

The calculation methodology is shown in the following table using the assessment of two pieces of packaging as an example.

Table 8-2: Scoring model for the quantitative recyclability assessment based on fictitious packaging examples

Criteria	A: Criteria in [%] Total = 100%	Packaging I		Packaging II	
		B: Assessment (0 bis 20)	A*B: Scoring-points	B: Assessment (0 bis 20)	A*B: Scoring-points
Stage 1: Allocation of packaging to the correct disposal system					
Collection matchable	10%	20	2	20	2
Level 2: Sorting capacity of mixed packaging (LWP) collected					
Minimum size	10%	20	2	20	2
Identifiability	20%				
Tinplate (Magnetisability)		-	-	-	-
Aluminium (Conductivity)		-	-	-	-
Plastic, LPB, PBC composite, PBC, glas (Surface characteristics)		15	3	15	3
Level 3: Suitability for mechanical recycling and provision of secondary products					
Quality of recycling method	20%	20	4	KO	KO
Separable parts that cannot be recycled	20%	15	3	-	-
Non-separable components, impurities	20%	20	4	-	-
			Bewertung		Assessment
Recyclability in total			18 out of 20		non-recyclable
Recyclability level 1			2 out of 2		(2 out of 2)
Recyclability level 2			5 out of 6		(5 out of 6)
Recyclability level 3			11 out of 12		KO

The further classification of the recyclability based on the scoring points determined is shown in the following table.

Table 8-3: Classification of recyclability based on the scoring model

Scoring points	% share lower limit of maximum score (20)	Classification of recyclability
greater than, equal to 19	95%	Very good
less than 19 and greater than or equal to 16	80%	Good
less than 16 and greater than or equal to 13	65%	Limited
less than 13 and greater than or equal to 10	50%	Considerably limited
less than 10	<50%	Poor
KO assessment in one criterion		Non-recyclable

For packaging containing removable components (for definition see Section 4), separate recyclability assessments are required for each component, as the components are usually subjected to different sorting and preparation methods. From a technical point of view, the most valid approach is to show separate recyclability assessments for each removable component. If the provision of an overall score is indispensable in an individual case, in a conservative assessment, it is necessary to examine whether a scoring average weighted with the weight shares from the individual packaging components or the overall score based on the assessment of the original packaging material (blister pack, tray, etc.) assesses the recyclability of the entire packaging on the most conservative basis.

Literature

- [APR 2021]: APR Design Guide for Plastics Recyclability. The Association of Plastics Recyclers. <https://plasticsrecycling.org/apr-design-guide> (berücksichtigt mit Stand vom 12.08.2021)
- [Bosewitz, 2013]: Bosewitz, S. [Hrsg.]: Kunststoffrecycling in Produkten – Herkunftskatalog von Erzeugnissen aus Kunststoffabfallströmen, 1. Auflage, VGE Verlag GmbH, Essen, 2013
- [bvse 2016]: Glasrecycling – ein in sich geschlossener Materialkreislauf. www.bvse.de/342/491/4. abgerufen am 24.02.2016
- [Consultic 2015] Analyse/Beschreibung der derzeitigen Situation der stofflichen und energetischen Verwertung von Kunststoffabfällen in Deutschland. Studie erstellt im Auftrag der Interessengemeinschaft der thermischen Abfallbehandlungsanlagen in Deutschland e.V.
- [Dehoust et al 2012]: Analyse und Fortentwicklung der Verwertungsquoten für Wertstoffe. UBA-Text 40/2012
- [Erdmann et al. 2009]: Einfluss von RFID-Tags auf die Abfallentsorgung. UBA-Text 27/2009.
- [FKN, 2007]: Fachverband Kartonverpackungen für flüssige Nahrungsmittel e.V. (Hrsg.): Getränkekarton – Im Kreislauf der Natur; www.getraenkekarton.de, abgerufen am 05.09.2017
- [GDA, W 18]: GDA - Gesamtverband der Aluminiumindustri e.V. (Hrsg.): Aluminium in der Verpackung – Herstellung, Anwendung, Recycling (Merkblatt W18); Düsseldorf
- [Gruber, 2011]: Gruber, E.: Papier- und Polymerchemie Vorlesungsskriptum zum Lehrgang „Papier-technik“ an der Dualen Hochschule Karlsruhe, <http://www.gruberscript.net>, abgerufen am 12.09.2017
- [Öko-Institut 2016]: Umweltpotenziale der getrennten Erfassung und des Recyclings von Wertstoffen im Dualen System. Ökobilanz für das Duale System Deutschland.
- [Saechtling] Karl Oberbach: Kunststoff-Taschenbuch. 28. Ausgabe Hanser Verlag
- [UBA_2016-1]: Umweltbundesamt (Hrsg.): Umweltbezogene Bilanzierung von „intelligenten“ und „aktiven“ Verpackungen hinsichtlich der Recyclingfähigkeit und Durchführung eines Dialogs mit Akteuren der Entsorgungs- und Herstellungsbranche, Dessau-Roßlau, April 2016
- [ZSVR 2022]: Mindeststandard für die Bemessung der Recyclingfähigkeit von systembeteiligungspflichtigen Verpackungen gemäß § 21 Abs. 3 VerpackG vom September 2022 . Stiftung Zentrale Stelle Verpackungsregister